

# pixsee

create beautiful moments

Quick Start Guide • 简易安装指南 • 簡易安裝指南

v. 2.10.0

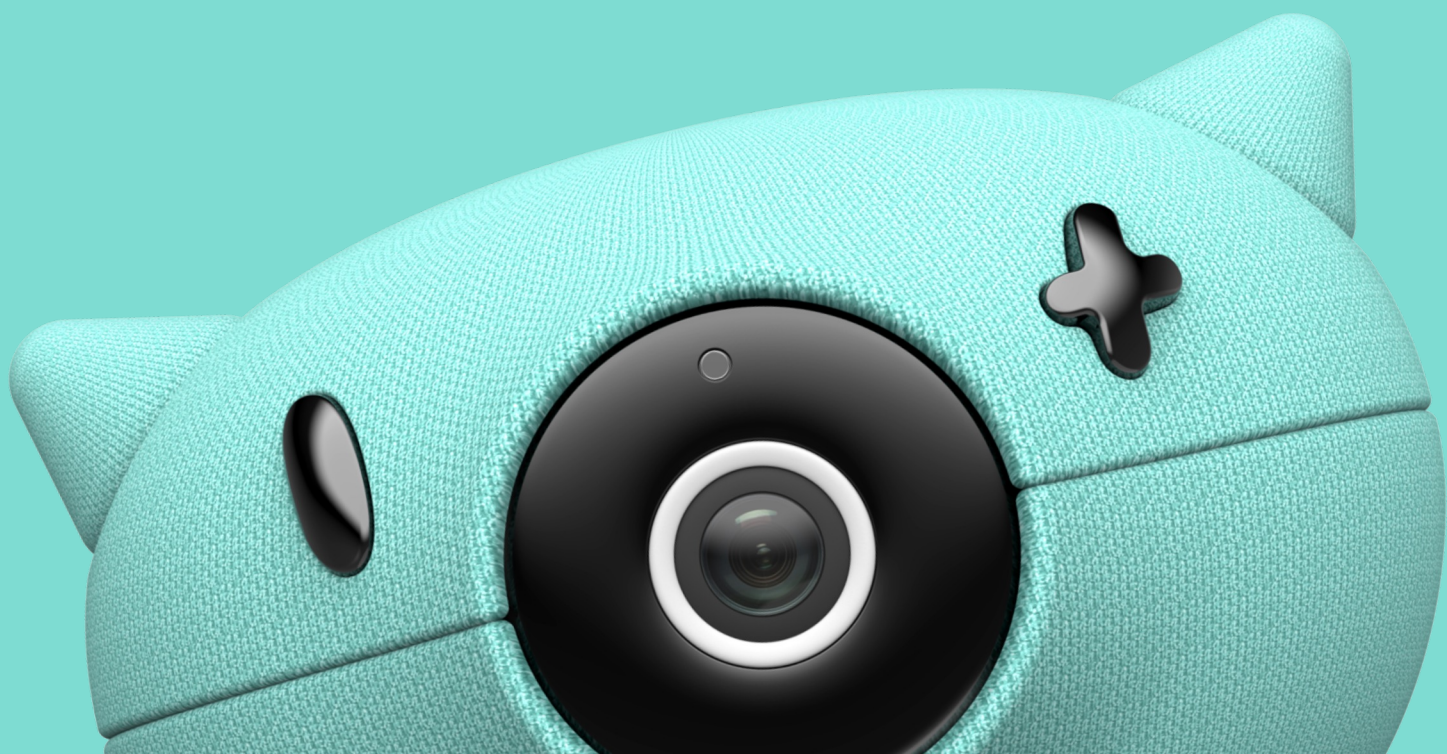



Thank you for purchasing pixsee.  
Start your exciting journey into parenthood with  
pixsee as the guardian of your loved one!

Any questions?  
[hello@pixseecare.com](mailto:hello@pixseecare.com)

Please keep your original receipt as proof of purchase (indicating the date of purchase) for any warranty or servicing purposes.

Please read this instruction manual carefully before using this product. Functions and features are subject to change without further notice.

Please visit the official pixsee site for new product updates and information.

Please visit our official pixsee website for the latest updates.

[www.pixseecare.com](http://www.pixseecare.com) [www.pixseecare.com/uk](http://www.pixseecare.com/uk)

# Instruction Manual

Product Safety and Warnings 4

Safety Instructions 5

## pixsee Smart Baby Camera Instruction Manual

Product Appearance and Functions 7

Camera Specifications and Light Indicators 8

Camera Installation and Wireless Connection 10

Camera Pairing and App Setup 11

## pixsee 5-in-1 Camera Stand Installation

Package Contents and Operating Modes 18

Free-Standing Installation 19

Wall Installation 21

## Other Product Statements and Instructions

Warnings and Precautions 23

Friendly Reminders, Product Disposal and Recycling 24

Product Cleaning, Maintenance and Disclaimers 25

In-Warranty Repair and Service 26





## Important Safety Instructions and Warnings



### Hazard Warnings: Potential Risk of Strangulation

- Please be aware that children are at risk of strangulation and suffocation accidents caused by rope entanglement.
- Please keep power cords away from children; maintain a distance of at least 3.5 feet (1m).
- Please do not leave the pixsee Smart Baby Camera in the baby cot or safety fence.
- Please only use the original AC adapter provided with the product. Do not plug the adapter into a power socket that does not meet all safety requirements in your respective country.
- This smart baby camera is a monitoring aid and cannot replace the functions and responsibilities of an adult supervision.
- Do not leave your infant unattended or alone at home. Infants need the constant care and attention of an adult.



### Warning: Do not let your child come into contact with or shake the camera stand.

- Pay close attention to the safety of the area the camera stand is being used in, and do not allow young children to touch it or play near it or with it. When not in use, it should be properly packed and stored in a safe place, out of children's reach, to effectively prevent accidents such as clamping, crushing or jamming. (The patented 5-in-1 pixsee Camera Stand is an optional accessory sold separately)

## Installation

- Please use the pixsee Smart Baby Camera with a mobile device. A device-to-device wireless connection is required for it to function properly. The wireless range will be affected by environmental factors.
- Any large objects containing metal (e.g., refrigerators, mirrors, blades, cabinets, metal doors or reinforced concrete) will affect the quality of wireless radio communications.
- Other solid objects, such as wall structures or other electronics that transmit wireless signals (e.g. televisions, calculators, wireless phones, fluorescent lamps, or dimmer switches), will potentially degrade the signal strength of this product.
- Using other products that utilize 2.4GHz wireless frequency, such as Wi-Fi® routers, Bluetooth™ systems, or microwaves, will potentially affect the wireless signal strength of this product. Therefore, it is recommended that you keep this product at least 1.5 meters away from the aforementioned products. If the aforementioned products are causing interference, please switch them off prior to using your pixsee device.
- In the event of poor wireless signal, please move your pixsee device to an alternative location.
- Please remove the black protective film of the lens first.

pixsee Smart Baby Camera  
Instruction Manual

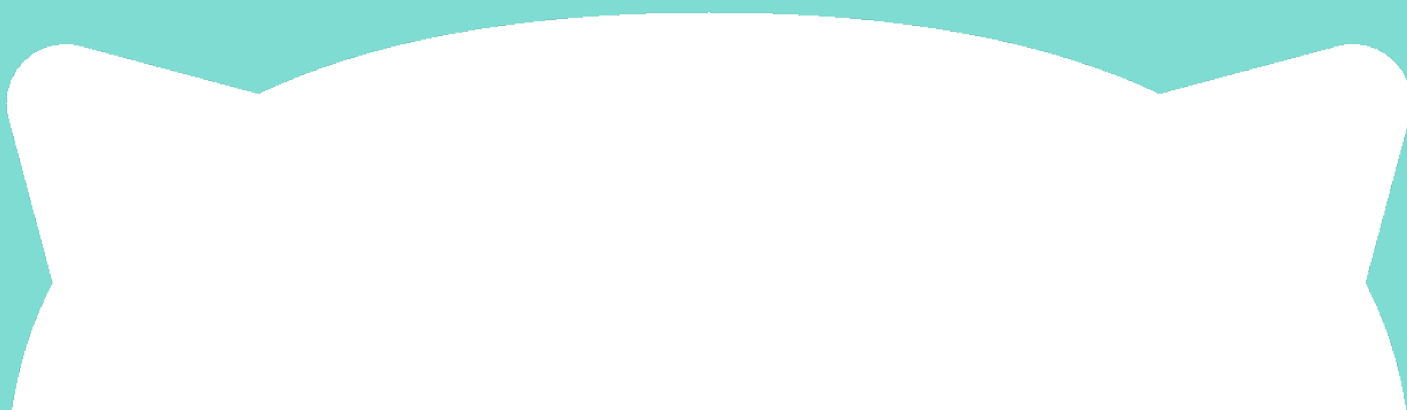



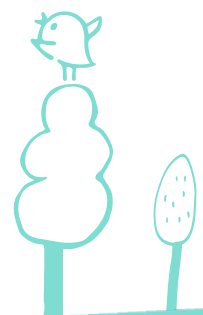
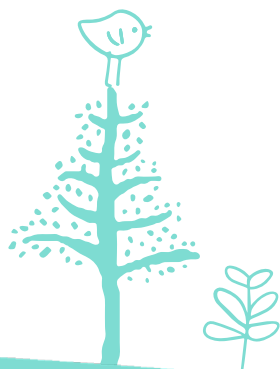
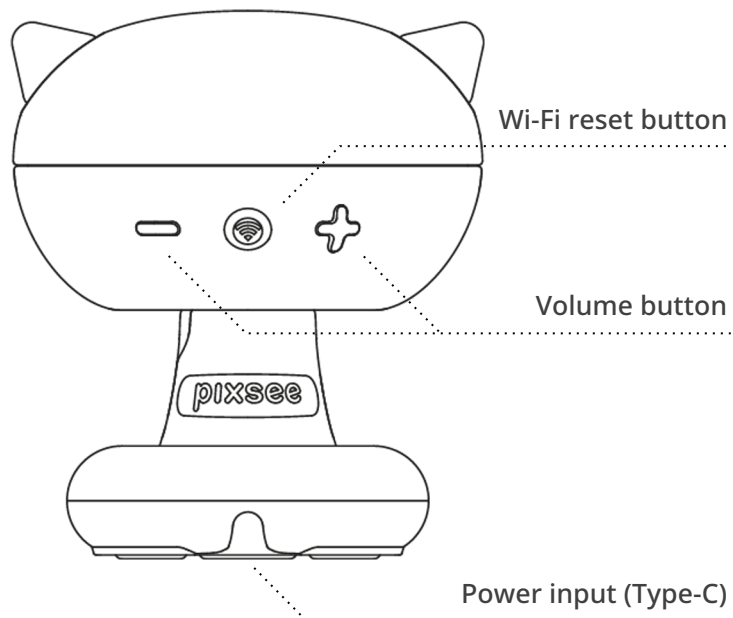
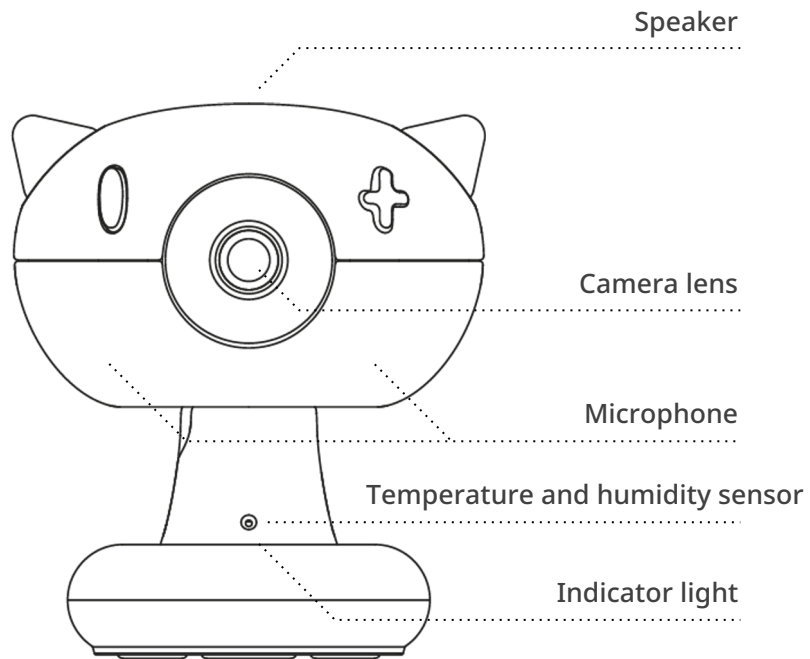





# Product Appearance and Functions



## Camera Specifications

Dimensions	116 x 112 x 131mm
Weight	322g
Camera lens	1080p FHD video, 5MP 6-layer optical glass lens, ultrawide lens module, anti-reflective and anti-glare coating
Night view mode	High quantum efficiency night vision CMOS sensor, no-red-light-emitting LED night vision filter (3 meters distance range, wavelength 940nm), ambient light sensor
Speaker and microphone	Built-in loudspeaker and high sensitivity dual microphone
Temperature and humidity sensor	Detection range Temperature: 0°C - 60°C (32°F - 140°F) Humidity: 10% - 90%
Security	Built-in secure crypto processor with AES-128 bank-level encryption
Power	Output: DC 5V=2A
Voltage	Input: 100 - 240V AC
Network requirements	Frequency: 802.11a/b/g/n/ac, 2.4GHz or 5GHz, WPA/WPA2-PSK(AES) encryption support, with a minimum of 5Mbps upload speed for best experience. <b>Note: Mobile hotspot not recommended.</b>
Mobile device system requirements for pixsee App	iOS 13.0 or above Android 10.0 or above
Accessories	Type-C Adapter (3m) Patented 5-in-1 pixsee Camera Stand (optional accessory, sold separately)

## Indicator light

-  Blinking orange: Initiate setup or system reset complete
-  Blinking red: System update in progress
-  Blinking blue: New Wi-Fi settings
-  Blinking green: Wi-Fi connecting
-  Solid green: Normal connection
-  Solid bluish violet: Silent mode
-  Solid cold white: Remote capture mode
-  Blinking cold white: Countdown timer
-  Alternating blue/green: Poor connection or signal

For the latest indicator light information, please refer to the official website.



## Camera Installation and Internet Connection

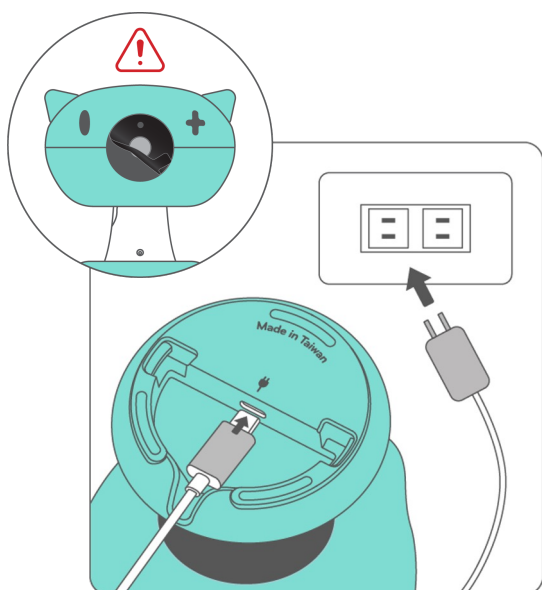

**Please remove the black protective film of the lens first.**

1. Connect your pixsee device to a power source.

Please use the USB power cable provided to turn on your pixsee device.

2. Confirm that the camera has turned on and the indicator light blinks orange.

Start the setup process.

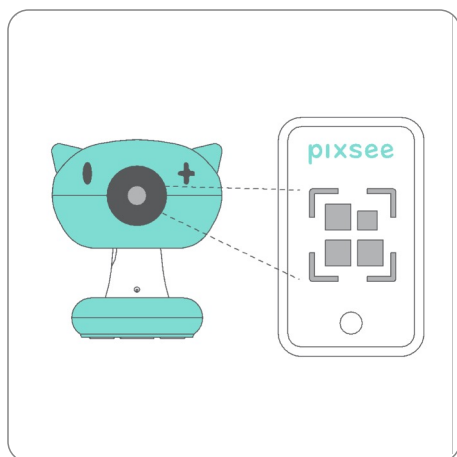
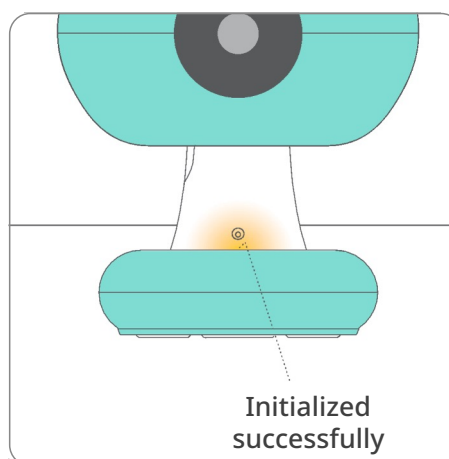

3. Download the pixsee app, then follow instructions to complete the pairing process.

Please follow instructions displayed on your phone.

4. Adjust the camera angle and setup is complete!

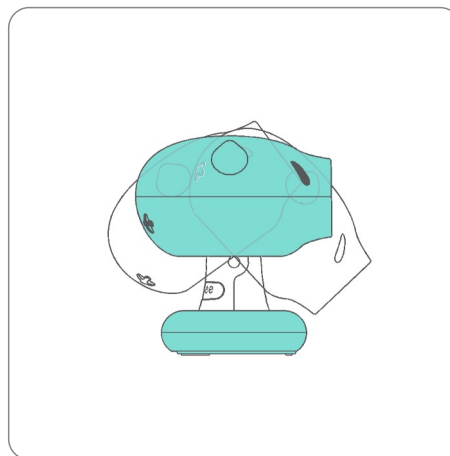

# Camera Pairing and App Setup

To ensure a stable connection and smooth usage with your pixsee device, before you start setup of your pixsee device and app, please ensure your Internet connectivity meets the following requirements:

**1. Your Wi-Fi is turned on and functioning properly.**

Note: If you have multiple Wi-Fi access points (AP), please choose the desired AP to connect to first.

**2. Turn on the Wi-Fi on your mobile device. Make sure you are connected to the desired AP you have previously chosen.**

## 1. Register / Sign-in

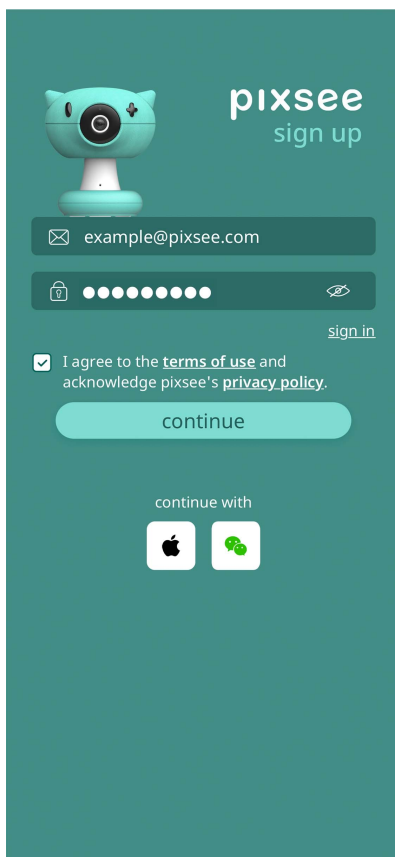

### 1-1 Register an account

Enter your email address and password, then click **continue** to complete your registration process. Once you're done, proceed to 1-2. You can also sign up with Apple ID or WeChat ID.

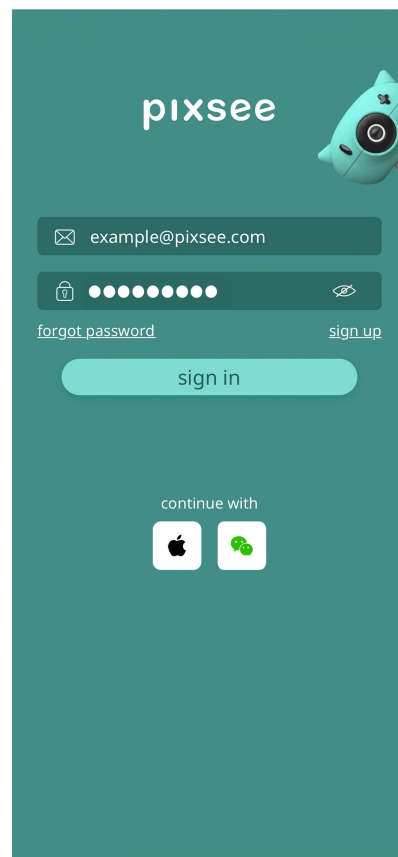

### 1-2 Sign in to your account

Go to the app's home page, then use your email and password or Apple ID/WeChat ID to sign in and start using the app.

# Camera Pairing and App Setup

## 2. Register your membership and complete pairing .....

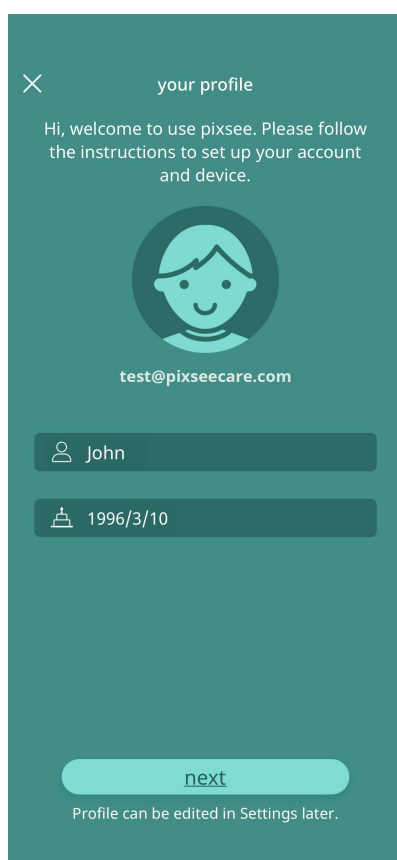

### 2-1 Create a user account

Enter your name and date of birth, then click **next** to continue.



### 2-2 Fill in baby's information

Enter your baby's name and relevant information, then click **next** to continue.



# Camera Pairing and App Setup

## 3. Register device

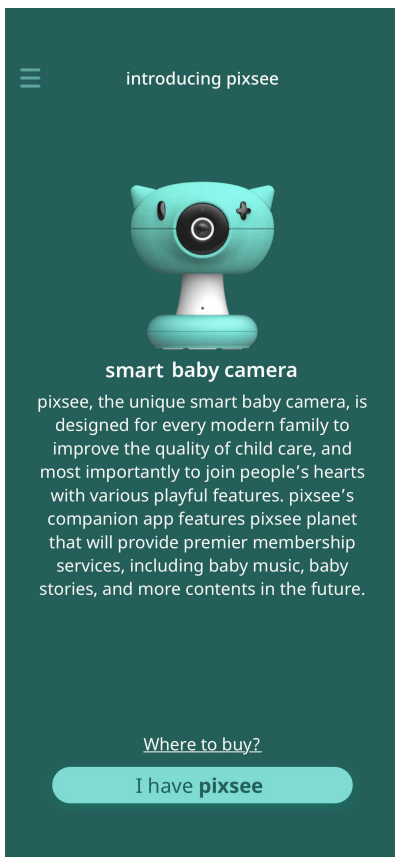

### 3-1 Add camera

Please click **I have pixsee** to continue.

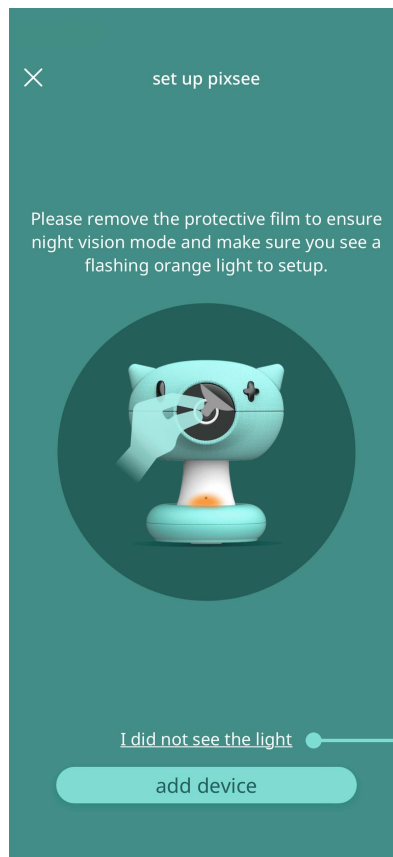

### 3-2 Confirm indicator lights

First confirm the camera shows a flashing orange light, then tap **add device**

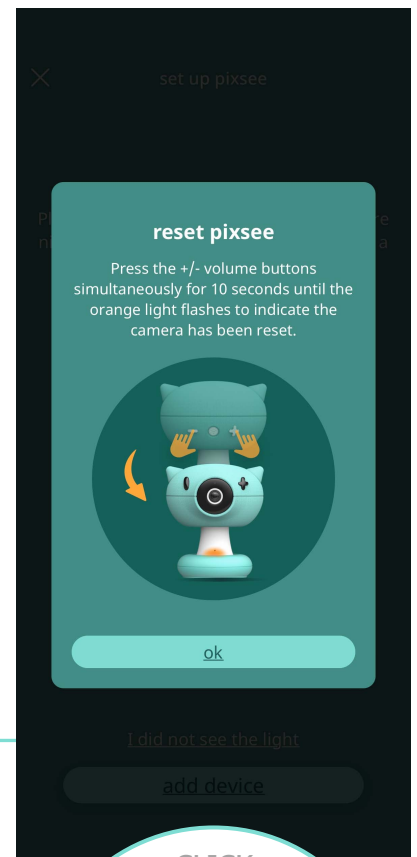

**CLICK**  
**I did not see the light**  
on your app if you do not see an orange blinking light on your pixsee device to reset.

# Camera Pairing and App Setup

## 4. Internet connection and device pairing

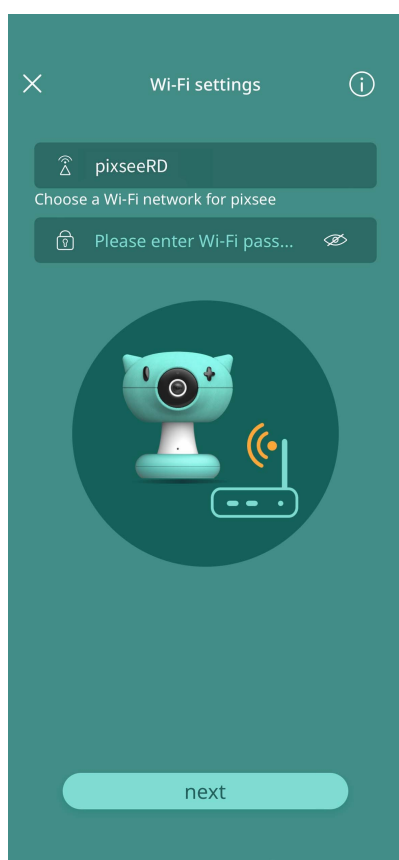

### 4-1 Wi-Fi settings

Your pixsee device will display the default Wi-Fi connection you've previously chosen. Please confirm the Wi-Fi connection you wish to connect to and enter the password. Click **next** to continue with the setup process.



### 4-2 QR code scan

Please place the QR code displayed on your mobile device about 20-25 cm in front of the pixsee camera to scan it and obtain network information. When you hear a voice prompt indicating a successful QR code scan, please click the button to continue the setup process.

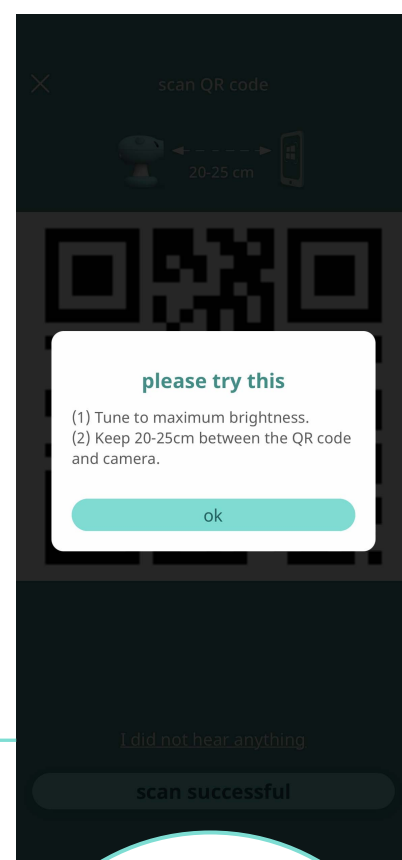

If you did not hear a voice prompt indicating a successful scan, please set your mobile phone display to full brightness, then adjust the distance between the QR code on your mobile device and the camera lens to try scanning again.

# Camera Pairing and App Setup

## 4. Internet connection and device pairing

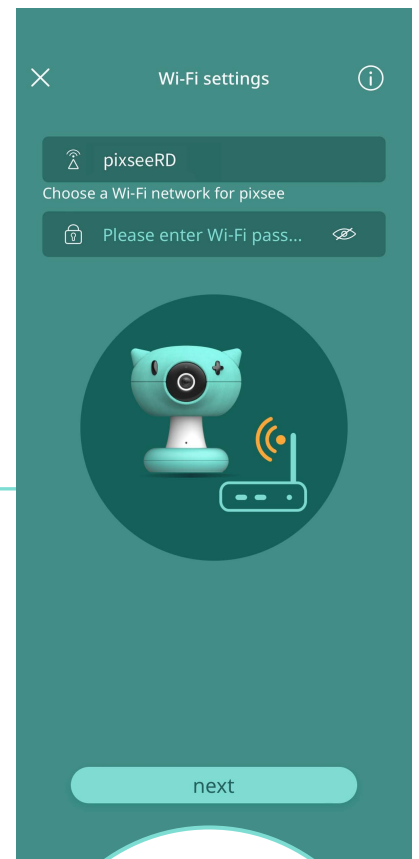
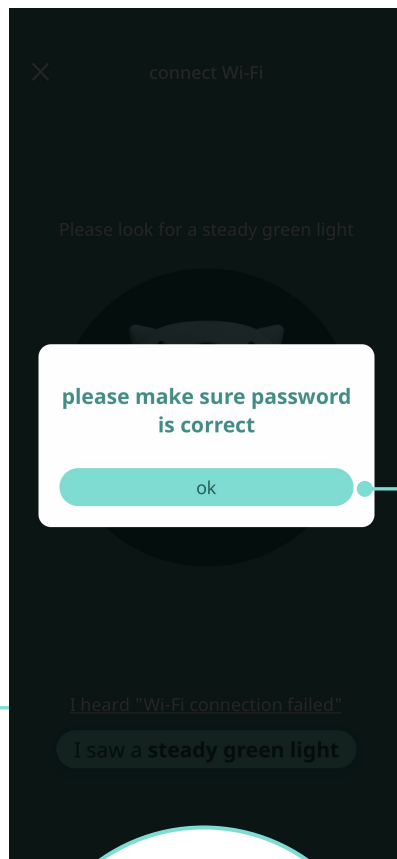
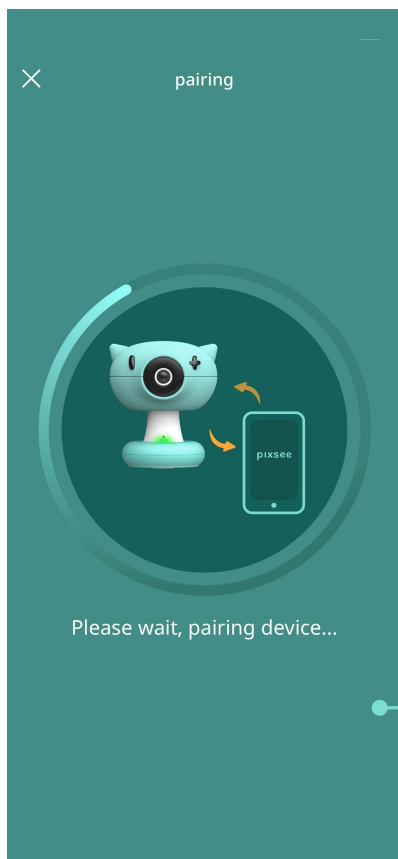

### 4-3 Connect to Wi-Fi

Once you see and have confirmed a steady green light, click the corresponding button on your app to continue the setup process.

#### Wi-Fi screenshot of connection failure

Please click **ok** and re-enter the correct Wi-Fi password

#### Reset network

Please follow the instructions to reset pixsee

# Camera Pairing and App Setup

## 4. Internet connection and device pairing

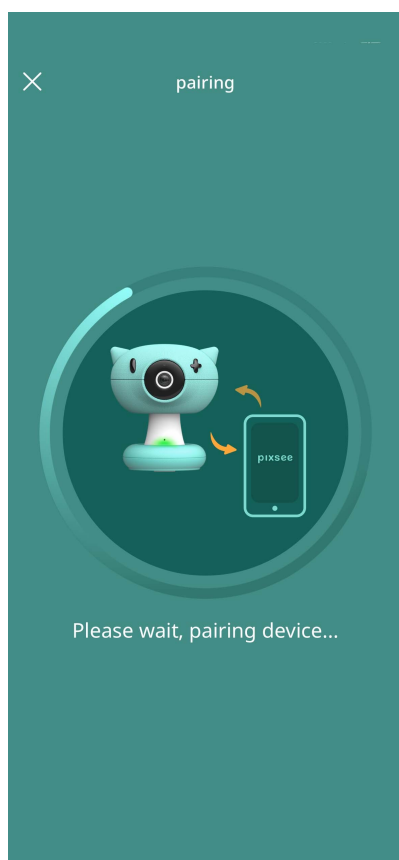

### 4-4 Pairing

Please wait 1-2 minutes for the pairing process to be completed.

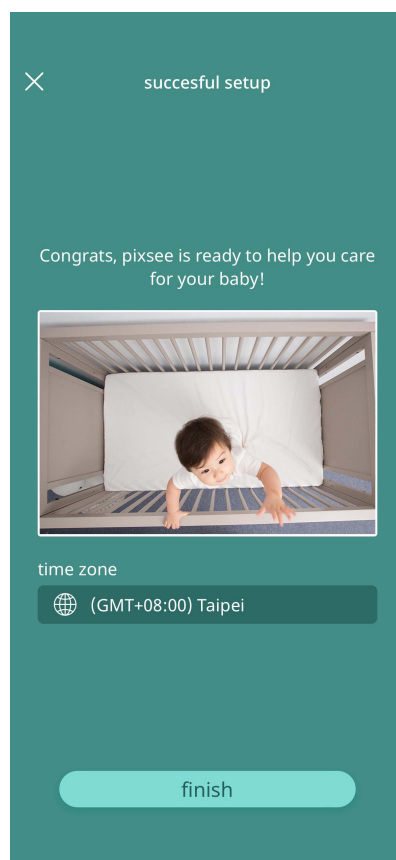

### 4-5 Complete pairing settings

When the display shows a live feed from your baby camera, this means setup has been completed. Enjoy a wonderful parenting journey with the help of your pixsee Smart Baby Camera!



# pixsee 5-in-1 Camera Stand Installation Installation Instructions

If you already own a pixsee Smart Baby Camera, please complete the camera's setup process first. Position your camera in the most fitting location and angle, then proceed with the camera stand installation.

# Package Contents

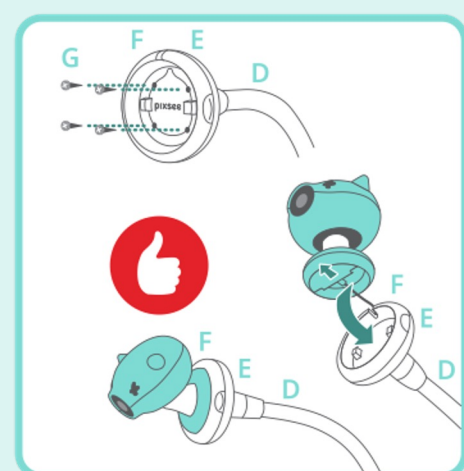
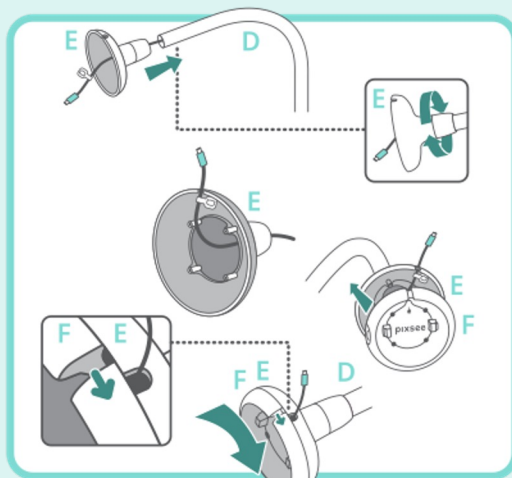
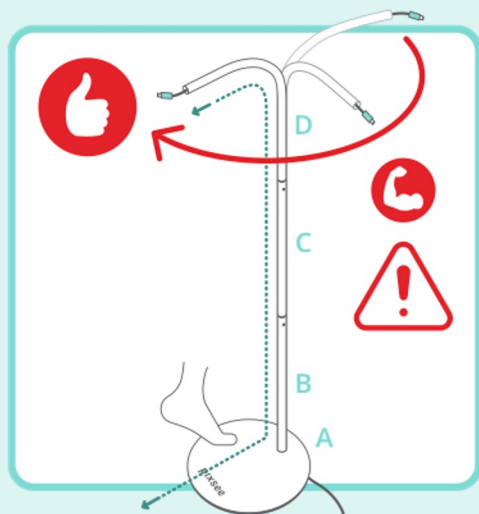
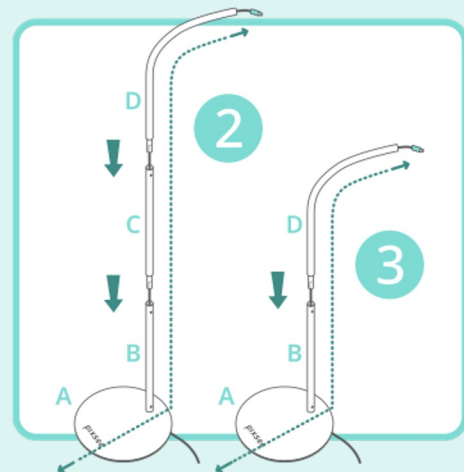
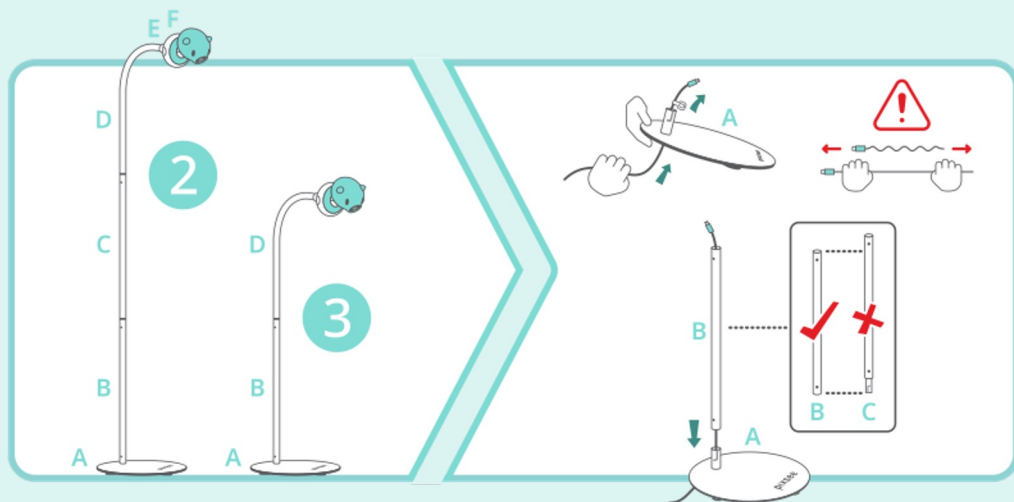
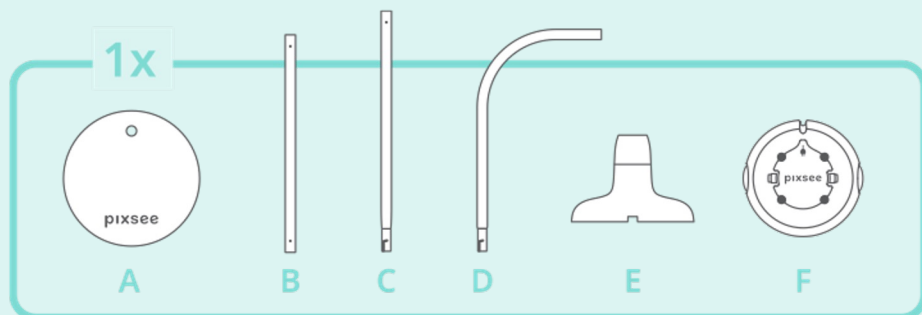

# Free-Standing Installation

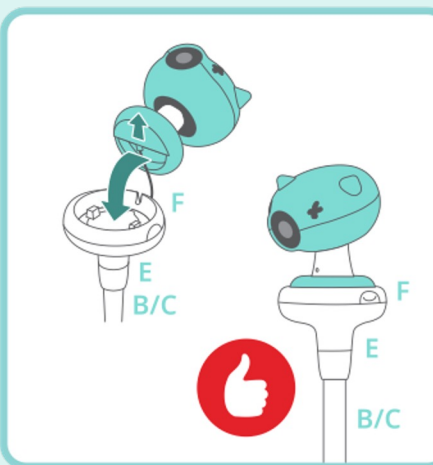
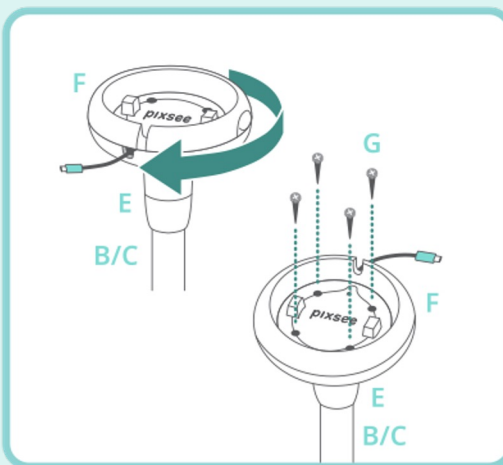
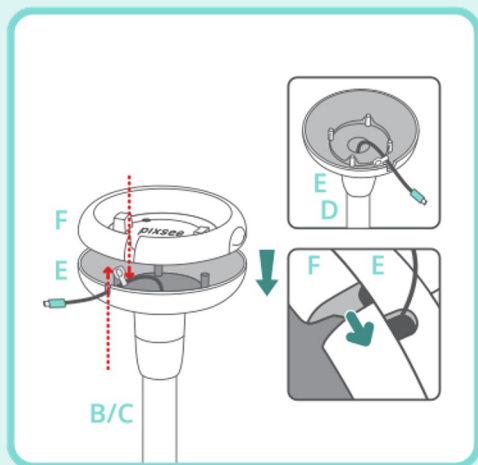
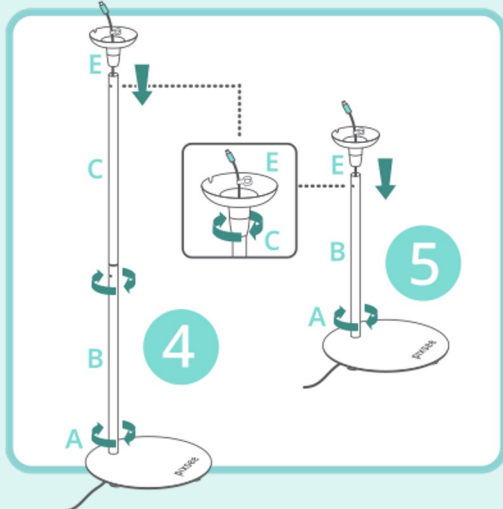
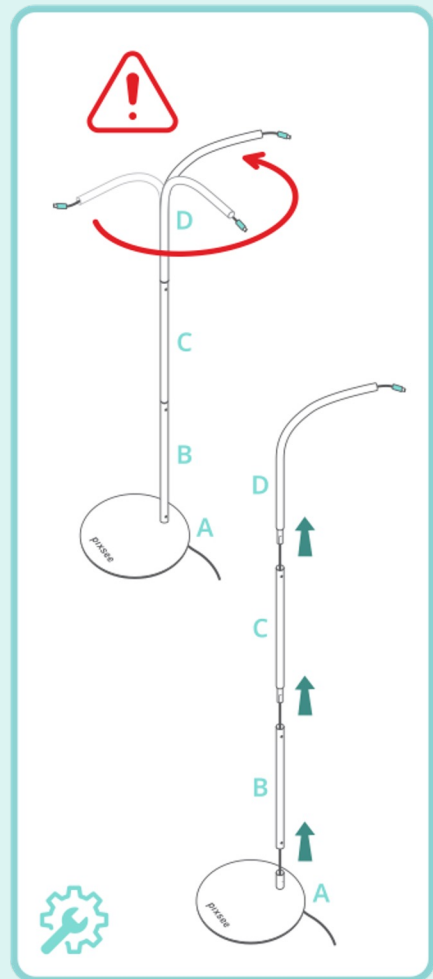
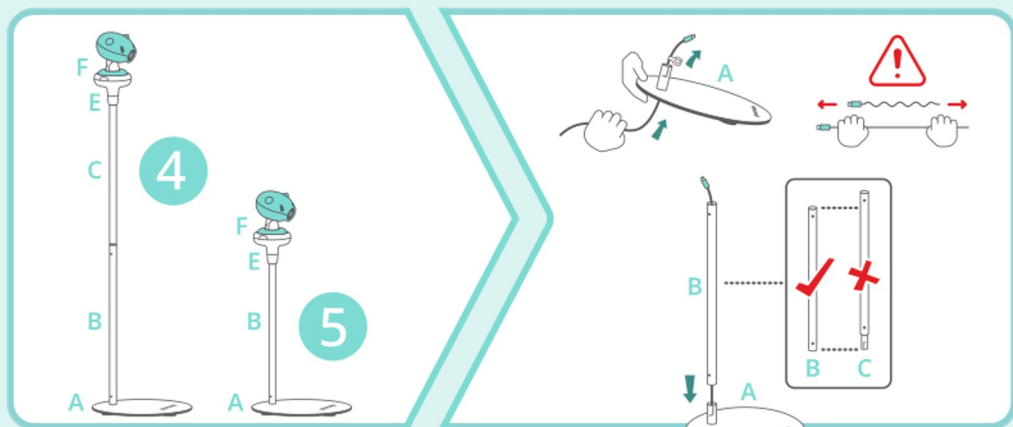

# Wall Installation

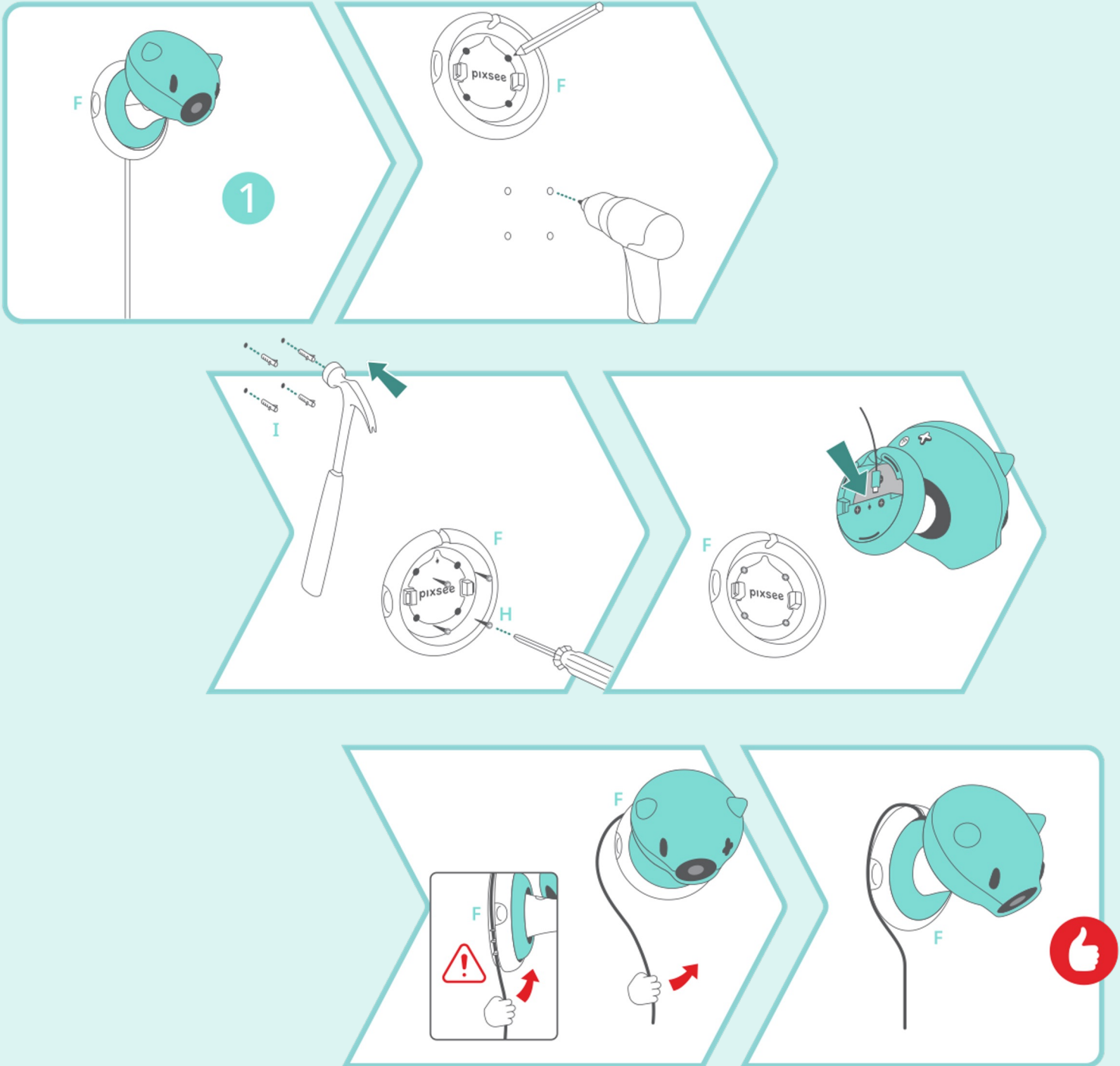



## Other Product Statements and Instructions



## Warnings & Precautions

- Children, the elderly and people with disabilities should use this product under supervision and guidance. Do not allow children to use this product as a toy without supervision.
- Do not use this product on a sloping or unstable surface, keep it away from heat sources to avoid damaging the plastic parts, and do not place it near or on any electrical appliances.
- This product needs to be plugged in to a power source before it can be used. If the power cord is unplugged, it cannot be turned on.
- A socket with a rated power supply of 110V-240V and a rated current of 5V/3A must be used with this product. Do not use a universal socket with other electrical appliances at the same time. Improper use of an AC adapter with the wrong power rating on this product might cause damage to the internal parts.
- Please do not use extension cords that have not been certified in your respective country/region to avoid the risk of fire. It may also affect the Wi-Fi transmission and the performance of this product.
- Please do not use faulty accessories on this product.
- Do not touch the plug contacts with sharp or metal objects.
- Please test this product and all its functions before actually using the product to familiarize yourself with this product during actual use.
- Do not cover this product or its cables with towels and blankets.
- The product will dissipate the heat generated during normal operation on the surface. Please do not leave the product on your knees or any part of your body for an extended period of time to avoid possible physical discomfort due to high temperature.
- Please avoid placing this product near magnetic materials (such as speakers and TVs).
- Do not use this product in an environment that could potentially leak flammable gas, or expose the product to rain or humid conditions.
- Avoid using the modem to connect to the Internet under thunder and lightning to avoid long-distance electric shock.
- Do not store this product near a fire source or throw it into a burning fire to avoid explosions or other accidents.
- To maintain aviation safety, please do not use this product during a flight. The network signal of this product may cause interference to the internal navigation systems of planes.
- If the product or the power cord is damaged, please do not attempt to disassemble the product. Please contact our company's after-sales service team.

### **RF Exposure warning**

- This device has been tested and meets applicable limits for Radio Frequency (RF) exposure. This equipment should be installed and operated with a minimum distance of 20 cm between the radiator and your body.

# Warnings & Precautions

## FCC Information

Changes or modifications not expressly approved by the party responsible for compliance could void the user's authority to operate the equipment.

This equipment has been tested and found to comply with the limits for a Class B digital device, pursuant to part 15 of the FCC Rules. These limits are designed to provide reasonable protection against harmful interference in a residential installation. This equipment generates, uses and can radiate radio frequency energy and, if not installed and used in accordance with the instructions, may cause harmful interference to radio communications. However, there is no guarantee that interference will not occur in a particular installation. If this equipment does cause harmful interference to radio or television reception, which can be determined by turning the equipment off and on, the user is encouraged to try to correct the interference by one or more of the following measures:

- Reorient or relocate the receiving antenna.
- Increase the separation between the equipment and receiver.
- Connect the equipment into an outlet on a circuit different from that to which the receiver is connected.
- Consult the dealer or an experienced radio/TV technician for help.

This device complies with part 15 of the FCC Rules. Operation is subject to the following two conditions: (1) This device may not cause harmful interference, and (2) this device must accept any interference received, including interference that may cause undesired operation.

## ISED Information

This device contains licence-exempt transmitter(s)/receiver(s) that comply with Innovation, Science and Economic Development Canada's licence-exempt RSS(s). Operation is subject to the following two conditions: (1) This device may not cause interference. (2) This device must accept any interference, including interference that may cause undesired operation of the device.

For information on detailed updates to this product manual, please visit the customer service page on the official pixsee website.

L'émetteur/récepteur exempt de licence contenu dans le présent appareil est conforme aux CNR d'Innovation, Sciences et Développement économique Canada applicables aux appareils radio exempts de licence.

L'exploitation est autorisée aux deux conditions suivantes: 1) L'appareil ne doit pas produire de brouillage; 2) L'appareil doit accepter tout brouillage radioélectrique subi, même si le brouillage est susceptible d'en compromettre le fonctionnement.

## CAN ICES-3(B)/NMB-3(B)

This device contains license-exempt transmitter(s)/receiver(s) that comply with Innovation, Science and Economic Development Canada's license-exempt RSS(s). Operation is subject to the following two conditions:

- (1) This device may not cause interference.
- (2) This device must accept any interference, including interference that may cause undesired operation of the device.

The device is restricted to indoor use only when operating in the 5150 to 5350 MHz frequency range, as to reduce the potential of harmful interference to co-channel mobile satellite systems.

les dispositifs fonctionnant dans la bande de 5 150 à 5 250 MHz sont réservés uniquement pour une utilisation à l'intérieur afin de réduire les risques de brouillage préjudiciable aux systèmes de satellites mobiles utilisant les mêmes canaux

### Informations d'exposition RF (MPE)

Cet appareil a été testé et répond aux limites applicables en matière d'exposition aux radiofréquences (RF). Cet équipement doit être installé et utilisé avec une distance minimale de 20 cm entre le radiateur et votre corps.

Company Name	SHENNONA CORPORATION
Address	1171 Montague Expressway Milpitas, CA 95035-6845
Tel Number	408-262-7877



California Residents  
**WARNING:** Cancer and reproductive harm -  
[www.p65warnings.ca.gov](http://www.p65warnings.ca.gov)

### EU Safety Information

#### Wireless Specifications and Declared Maximum RF Power:

- 2400 – 2483.5 MHz (Wi-Fi 2.4GHz): 20dBm (e.i.r.p)
- 5150 – 5250 MHz (Wi-Fi 5GHz): 23dBm (e.i.r.p)
- 5250 – 5350 MHz (Wi-Fi 5GHz): 20dBm (e.i.r.p)
- 5470 – 5725 MHz (Wi-Fi 5GHz): 20dBm (e.i.r.p)
- 5745 – 5850 MHz (Wi-Fi 5GHz): 14dBm (e.i.r.p)

#### Waste Electrical and Electronic Equipment (WEEE)



This symbol means that according to local laws and regulations your product and/or its battery shall be disposed of separately from household waste. Your product is designed and manufactured with high quality materials and components, which can be recycled and reused.

When this crossed-out wheeled bin symbol is attached to a product it means the product is covered by the European Directive 2012/19/EU.

Please find out for yourself about the local separate collection system for electrical and electronic products. Please act according to your local rules and do not dispose of your old products alongside your normal household waste.

The correct disposal of your old product will help prevent potential negative consequences for the environment and human health.

Rated Supply Voltage	5 Vdc
Max. Load Current	3 A
Rated Power (Max.)	10 W

### Environmental Specifications

Operating Ambient Temperature	0°C – 60°C
Relative Humidity	Up to 90 % non-condensing

**RF Exposure Statement:**

This device has been tested and meets applicable limits for Radio Frequency (RF) exposure.

This equipment should be installed and operated with a minimum distance of 20 cm between the radiator and your body.

This device meets EU requirements and the International Commission on Non-Ionizing Radiation Protection's (ICNIRP) regulations on the limitation of exposure of the general public to electromagnetic fields by way of health protection.

The device is restricted to indoor use only when operating in the 5150 to 5350 MHz frequency range.

AT	BE	BG	HR	CY	CZ	DK
<b>EE</b>	FI	FR	DE	EL	HU	IE
<b>IT</b>	LV	LT	LU	MT	NL	PL
<b>PT</b>	RO	SK	SI	ES	SE	UK
<b>IS</b>	LI	NO	CH	TR		

# EU Declaration of Conformity (DoC)

Hereby we,

Name of manufacturer	Compal Electronics, Inc.
Address	No.581 & 581-1, Ruiguang Rd., Neihu District, Taipei, (114) Taiwan
Telephone number:	+886 2 87516228

**Declare that this DoC is issued under our sole responsibility and that this product:**

Product description	Smart Baby Camera
Type designation(s)	SC-PIXM01
Trademark	PIXSEE

**Complies with the following Directives:**

2014/53/EU, 2011/65/EU

**The following standards have been applied:**

**Article 3.1a: Safety and Health**

EN 62311:2020, EN50665:2017, EN 62368-1:2014/A11:2017

**Article 3.1b: EMC**

EN 301489-1 V2.2.3, EN 301489-17 V3.2.4, EN  
EN 301489-1 V2.2.3, EN 301489-17 V3.2.4, EN 55032:2015/A11:2020  
EN 55035:2017/A11:2020  
EN 61000-3-2: 2014 Class A, EN 61000-3-3: 2013

**Article 3.2: RF Spectrum Efficiency**

EN 300328 V2.2.2, EN 301893 V2.1.1, EN 300440 V2.2.1

**Additional Compliance**

RoHS EN50581:2012

# UK Declaration of Conformity (DoC)

Hereby we,

Name of manufacturer: Compal Electronics, Inc.

Address: No.581 & 581-1, Ruiguang Rd., Neihu District, Taipei, (114) Taiwan

Telephone number: +886 2 87516228

**Declare that this DoC is issued under our sole responsibility and that this product:**

Product description: Smart Baby Camera

Type designation(s): SC-PIXM01

Trademark: PIXSEE

**Complies with the following Regulations:**

Radio Equipment Regulations 2017; The Restriction of the Use of Certain Hazardous Substances in Electrical and Electronic Equipment Regulations 2012

**The following standards have been applied:**

**Regulation 6.1a: Health and Safety**

EN 62311:2020, EN50665:2017, EN 62368-1:2014/A11:2017

**Regulation 6.1b: Electromagnetic Compatibility**

EN 301489-1 V2.2.3, EN 301489-17 V3.2.4, EN 55032: 2015/A11:2020,

EN 55035:2017/A11:2020

EN 61000-3-2: 2014 Class A, EN 61000-3-3: 2013

**Regulation 6.2: Radio Spectrum**

EN 300328 V2.2.2, EN 301893 V2.1.1, EN 300440 V2.2.1

**Additional Compliance**

RoHS EN50581:2012

## Friendly Reminders

In order to reduce the risk of Sudden Infant Death Syndrome (SIDS), the Centers for Disease Control and Prevention (CDC) has compiled a few tips on what parents and caregivers can do to help babies sleep safely. We hope every baby will sleep safely, warm and sound.

- Babies sleeping in the same bed with others is one of the risk factors for SIDS. Even with parents or multiple siblings, it is recommended for infants to sleep in the same room but on different beds.
- When using a towel or blanket to keep your baby warm, you should wrap it on your baby's chest and expose their arms to reduce the chance of the towel or blanket covering your baby's face, or wear one piece or sleep sack pajamas.
- The surface of the crib must be solid and flat, and there must be no soft objects such as pillows, stuffed toys, etc. Do not allow babies to sleep on sofas, chairs, cushions or on their parents or caregivers.
- To prevent overheating, do not put on too much clothing on your baby or wrap them too tightly. Ensure good ventilation if there is no air conditioning available.
- Ensure a smoke-free environment for your baby, and do not allow anyone to smoke near your loved one.

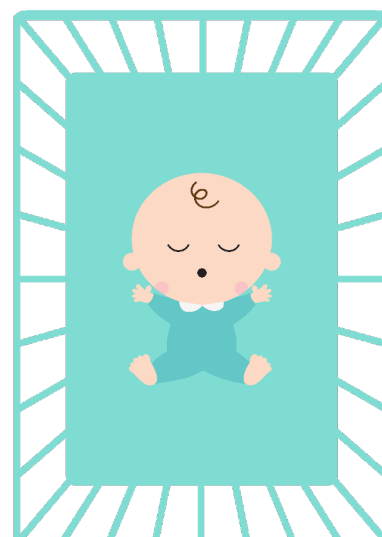

## Product Disposal and Recycling Information

- Please abide by the laws and regulations in your area to properly dispose of this product and recyclable items. Please contact your local government agency to understand the relevant laws and regulations, and identify recycling items and recycling collection points in your area.
- Please take this product to the collection point for recycling of electrical and electronic equipment in accordance with local regulations. Do not dispose of this product together with normal household waste. By recycling waste equipment, you can make an important contribution to environmental protection.



## Cleaning and Maintenance (camera)

- Please use a clean dry cloth for cleaning and wiping.
- Do not use strong solvents such as thinners, benzene-containing solvents or other chemical solvents next to or on this product.
- This product only features splash-proof water protection. Please do not expose the product to water splashes, showers, or any contact with sea water, salt water, chlorinated water or beverages and other liquids. Improper use will void your warranty.
- Before cleaning your product, please ensure power is turned off, and the power cord from the AC adapter is disconnected.

## Cleaning and Maintenance (stand)

- Please use a clean dry cloth for cleaning and wiping.

## Disclaimers

- This instruction manual is provided “as-is”, without warranties of any kind, either directly expressed or implied. To the maximum extent permitted by applicable laws, we provide the document AS IS AND WITH ALL FAULTS. You shall bear all the risks arising from the use of this manual.
- You fully understand and agree that we reserve the right to make changes to this instruction manual. In the event of changes to product specifications or product drivers, this manual will be updated accordingly.
- For information on detailed updates to this instruction manual, please visit the customer service page on the official pixsee website.
- Please refer to the description page of the terms of use and privacy policy in the app to view software disclaimers for use of the pixsee app.

## In-Warranty Repair and Service

This product's warranty repair and service will no longer apply should the following occur:

(1) Unauthorized repair, changes to specifications, replacement of parts, or any other actions not authorized by us.

(2) Inability to provide the product serial number and proof of purchase.

When you start to use this product, you are deemed to have read, understood, accepted and agreed to all terms and contents of this instruction manual, important warnings and safety tips, precautions and disclaimers.

You agree to the use of this product only for its intended purposes and agree to abide by these terms and any relevant policies or guidelines.

For information on detailed updates to In-Warranty Repair and Service, please visit the customer service page on the official pixsee website.

感谢您购买本产品，  
与pixsee拍宝儿一起开启陪伴宝宝的惊喜旅程！

如有疑问请联系  
[hello@pixseecare.com](mailto:hello@pixseecare.com)

请您保留原始的购买收据并注明购买日期，作为保修期内维修服务时的依据。  
使用产品前请仔细阅读本说明书，其中描述的功能如有更改，恕不另行通知。

请随时参阅官方网站以获得最新产品信息。  
[www.pixseecare.com.cn](http://www.pixseecare.com.cn)

# 说明书内容

重要警示语与安全提示 28

安装准则 29

## 产品使用说明

外观功能简介 31

规格与灯号说明 32

安装及联机步骤说明 33

配对及app使用设置 34

## 五合一成长支架组安装说明

内容物与使用模式 41

立地式安装步骤 42

壁挂式安装步骤 43

## 注意及其他声明事项说明

注意事项与警示语 45

友情提醒、设备废弃及回收处理 46

清洁保养与免责声明 47

保修维护 47



## 重要警示语与安全提示



### 警告：存在绞勒窒息的危险

- 请留意孩童易受绳索缠绕而发生绞勒窒息的意外。
- 请勿让孩童接触电线 (请保持3.5英尺 (1米) 以上的距离)。
- 请勿将本产品放在婴儿床或婴儿护栏内。
- 请使用本产品随箱提供的变压器，并切勿将上述变压器插入未经国家安全认证的延长线。
- 本产品为辅助工具，无法取代具备成人监督意义的功能及责任。
- 请勿将婴儿独自留在家中，婴儿必须随时有成人在旁照顾并回应其需求。



### 警告：请勿让宝宝触碰摇晃支架。

- 应留意立架使用场所安全，不可让幼童触碰嬉戏。不使用时也应妥善收纳，置于孩童无法接触的安全地点，才能有效避免孩童被夹伤、压伤或卡住等意外事故的发生。  
(专利五合一成长支架需另行选购)

## 安装准则

- 请将pixsee拍宝儿智能监护摄像头和手机装置一起使用，您必须在上述两个装置之间建立无线连接，该连接范围将受到联网环境条件的影响。
- 任何大型金属物体，如冰箱、镜子、刀具、橱柜、金属门或钢筋混凝土皆可能阻挡本产品的无线连接信号。
- 其他固体如墙壁等结构，或无线电及电气设备(例如电视、计算机、无线电话、萤光灯或调光开关等)，也可能降低本产品的信号强度。
- 使用其他2.4GHz类产品，例如无线网络（Wi-Fi®路由器）、Bluetooth™系统或微波炉，也可能干扰本产品的信号强度。因此请保持本产品距离上述类型产品至少1.5米的距离；或当上述类型产品疑似引起干扰时，请将其关闭。
- 如果信号微弱，请尝试移动本产品至房间不同位置。

pixsee 拍宝儿智能监护摄像头  
产品使用说明

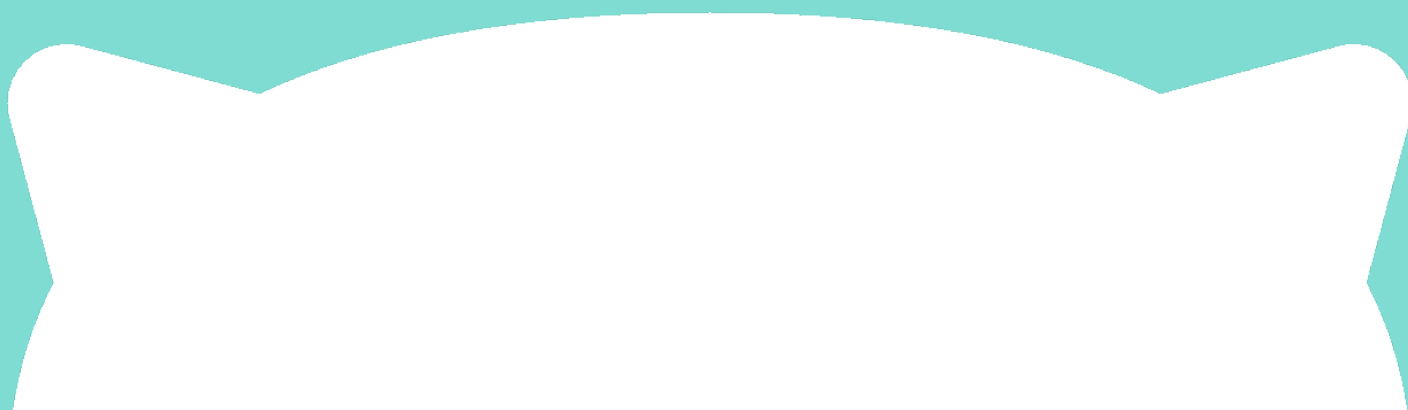

## 产品外观功能简介

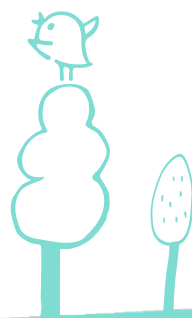
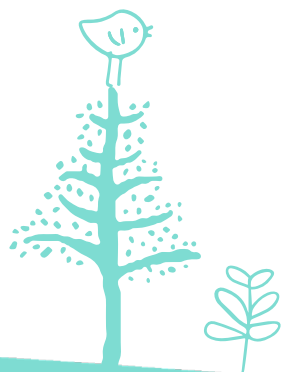
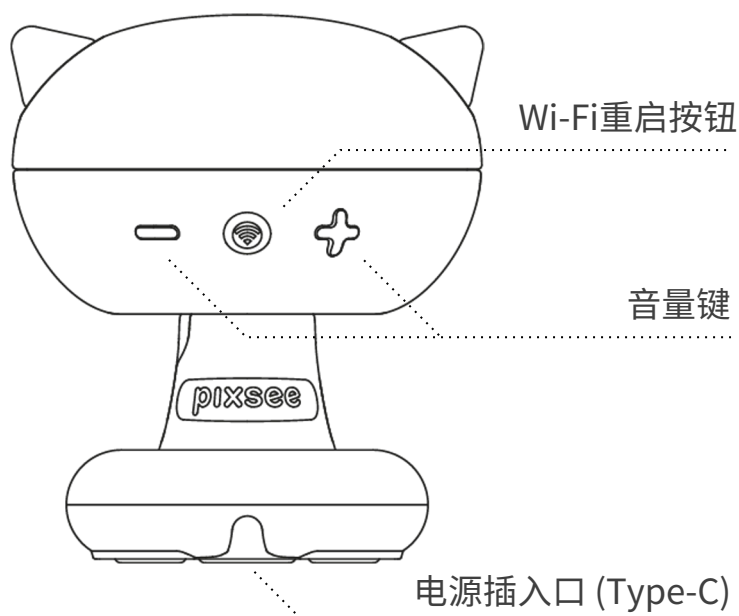
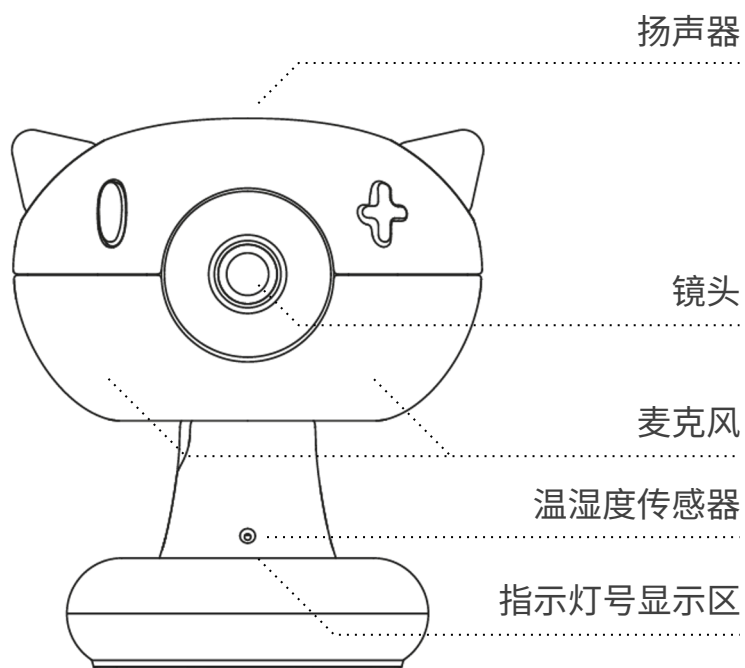

## 产品规格

外观尺寸	116 x 112x 131mm
重量	322g
摄影镜头	1080p FHD摄影画质、500万像素6层全玻璃镜头、超广角镜头模块、抗反射、防眩光镀膜
夜视功能	高量子效率夜视CMOS感光组件、无红光LED夜视滤镜(3米距离范围、波长940nm)、环境光源传感器
喇叭及麦克风	内置喇叭与高感度麦克风
温湿度侦测器	可侦测环境范围： 温度为0°C ~ 60°C (32°F ~ 140°F) 湿度为10% ~90%
安全性	内置安全加密芯片、AES-128 银行级加密技术
电源	直流5伏特2安培
电压	100 ~ 240伏特
联网环境需求	Wi-Fi 802.11a/b/g/n/ac, 2.4GHz 或 5GHz (支持WPA, WPA2加密); 为获得较佳使用体验, 建议WiFi 上下传速度至少各 5Mbps 以上 <b>提醒: 使用手机热点连线, 可能影响连线及浏览品质</b>
App行动装置系统版本需求	iOS 13.0 或以上 Android 10.0 或以上
配件	电源线 (3米) 专利五合一成长支架 (需另行选购)

## 灯号说明

- 橘黄闪灯: 装置首次启动或完成重启
- 红色闪灯: 系统升级中
- 蓝色闪灯: 新增Wi-Fi设置
- 绿色闪灯: Wi-Fi联机中
- 绿色恒亮灯: 正常联机运作中
- 蓝紫色恒灯: 静音模式
- 冷白色恒灯: 遥控拍照模式
- 冷白色闪灯: 倒数计时状态
- 蓝+绿色闪灯: 网路连线或传输讯号状况不佳

最新的灯号说明请参阅官方网站





## 摄像头安装及联机步骤说明

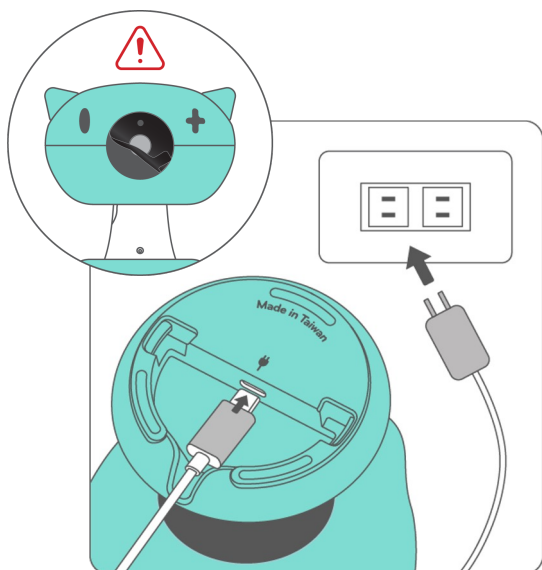

请先将镜头黑色保护膜撕除

### 1 连接电源

请使用随盒提供的USB电源线连接至pixsee拍宝儿智能监护摄像头

2 确认装置启动灯号  
便可准备进行行动装置app设定连接步骤

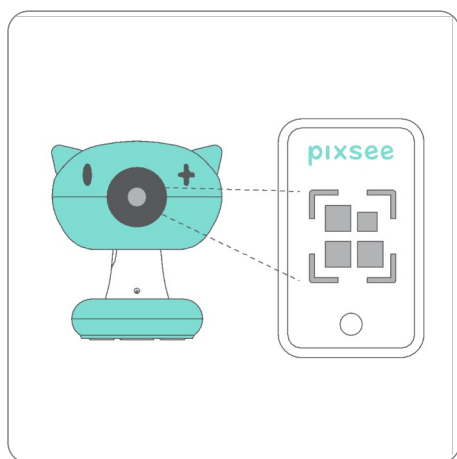
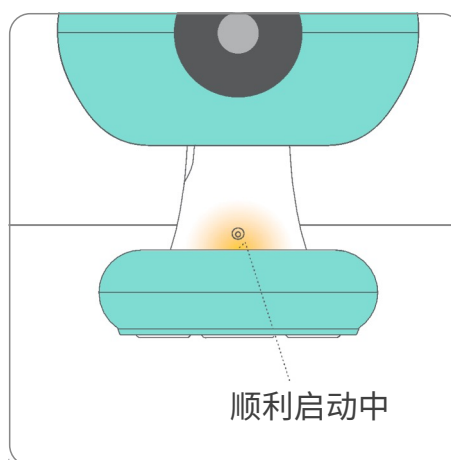

3 下载pixsee 拍宝儿 app，  
依循指示操作，与装置完成配对。

请按照app指示步骤操作

4 调整镜头角度，完成!

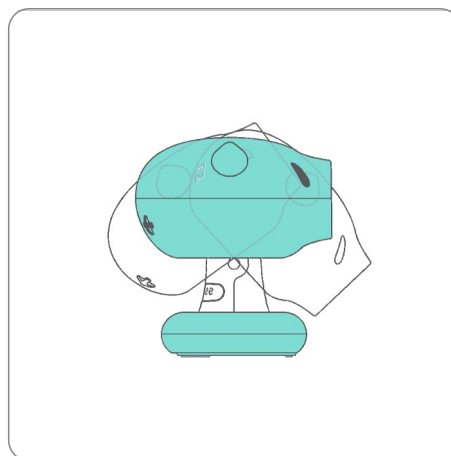

## 配对及app使用设置

为了确保pixsee拍宝儿智能监护摄像头联机质量与使用体验，在您进行摄像头及app设定前，请先确认以下网络设定状态：

### 1 家中Wi-Fi网络已开启并联机正常。

注意：如果家中Wi-Fi网络AP超过一个以上，请您先选择并连接网络AP。

### 2 手机开启Wi-Fi，并且确认手机Wi-Fi的设置已成功联机到您指定的网络AP。

## 1. 注册/登录账号



### 1-1 开始注册

输入电子邮件与密码，点击 **继续**，继续电子信箱认证流程，完成认证流程，执行1-2。您也可利用WeChat/Apple ID完成注册及登入。



### 1-2 登录账号

进入app，输入电子邮件与密码，或是以WeChat/Apple ID登录，开始使用app。

# 配对及app使用设置

## 2. 建立及绑定会员数据



### 2-1 建立使用者账号

输入您的名字与生日信息，  
点击 **下一步** 继续。



### 2-2 建立宝宝信息

输入宝宝名字与相关信息，  
点击 **下一步** 继续。

# 配对及app使用设置

## 3. 建立装置



### 3-1 新增装置

请点击 **我已经拥有pixsee** 继续下一步。



### 3-2 确认灯号

先确认监护器上灯号显示橘灯闪动，点击 **新增摄像头**

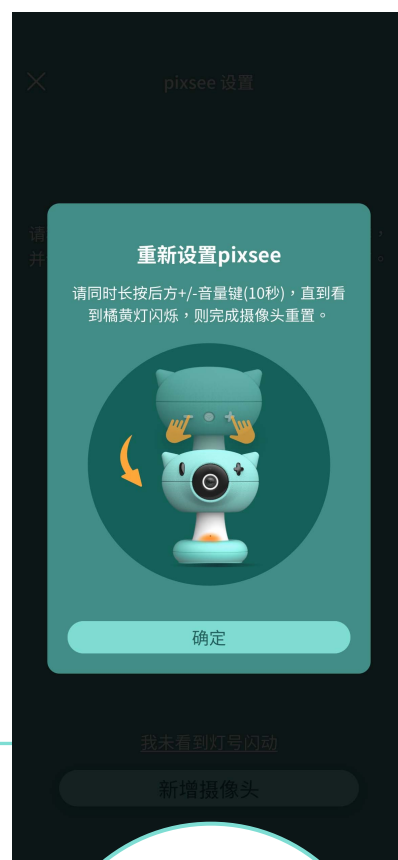

如果机器未显示灯号  
请按下  
**我未看到灯号闪动**  
进行重置(Reset)

# 配对及app使用设置

## 4. 网络联机与装置配对



### 4-1 Wi-Fi设置

pixsee会出现预设联机使用的Wi-Fi网络，请确认欲使用的Wi-Fi网络，并输入Wi-Fi密码，点击 **下一步** 继续设置。



### 4-2 QR code 扫描

请将手机屏幕上的QR code，放置于pixsee镜头前约20~25cm位置进行扫描，并取得网络联机信息，当听到语音提示 QR code scan successful 后请点击按键，继续进行设置。



如果没听到扫描成功的提示音，请将屏幕亮度调整至最亮，或移动手机二维码画面和镜头的距离进行重新扫描，直到扫描成功

# 装置配对及app使用设置

## 4. 网络联机与装置配对



### 4-3 连接Wi-Fi

当看到并确认装置上灯号显示绿灯恒亮，按下指示按键继续进行设置。

Wi-Fi  
连接失败界面  
请点击确认后，重新  
输入正确的  
Wi-Fi密码

重新设置连线  
请遵照指示重新设定  
pixsee

# 装置配对及app使用设定

## 4. 网络联机与装置配对



### 4-4 联机配对

进行联机配对约需1~2分钟，请耐心等待配对过程。



### 4-5 完成配对设定

当界面出现联机界面显示设置成功，就可以开始体验pixsee美妙愉快的育儿旅程啦~

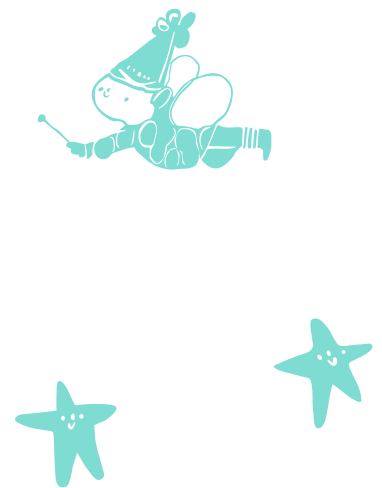

## 五合一成长支架组 安装说明

如已持有pixsee拍宝儿智能监护摄像头，请先完成装置设置，  
确认最佳摄影位置后再进行支架安装。



# 内容物与使用模式

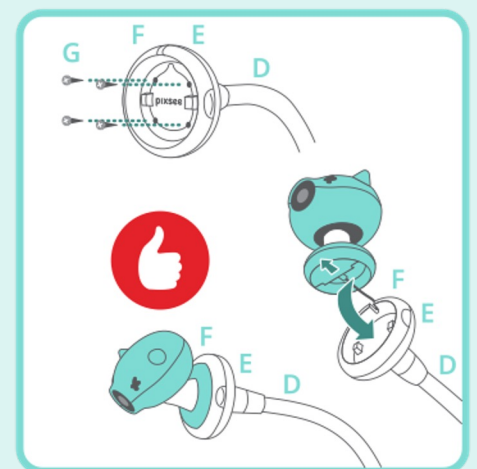
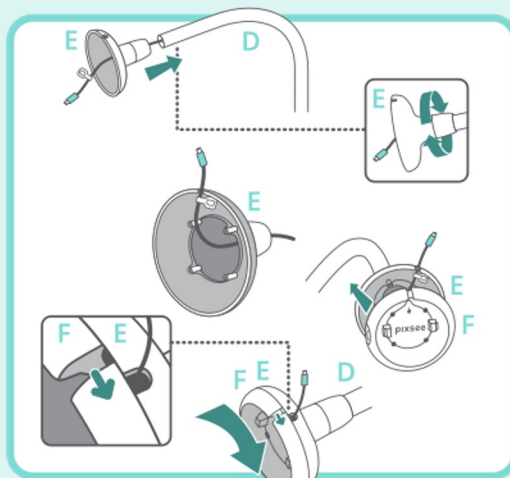
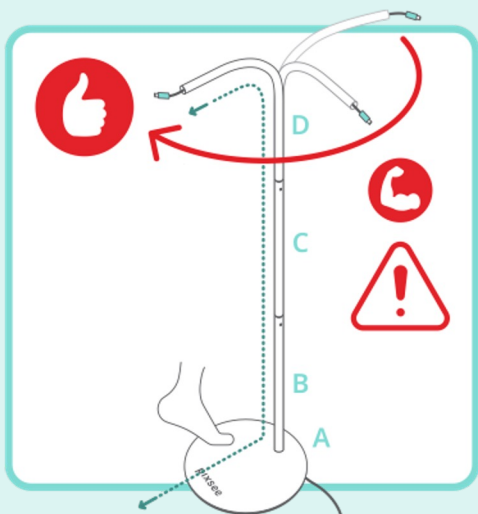
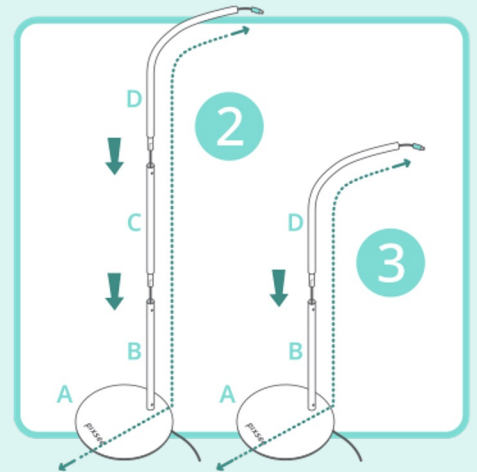
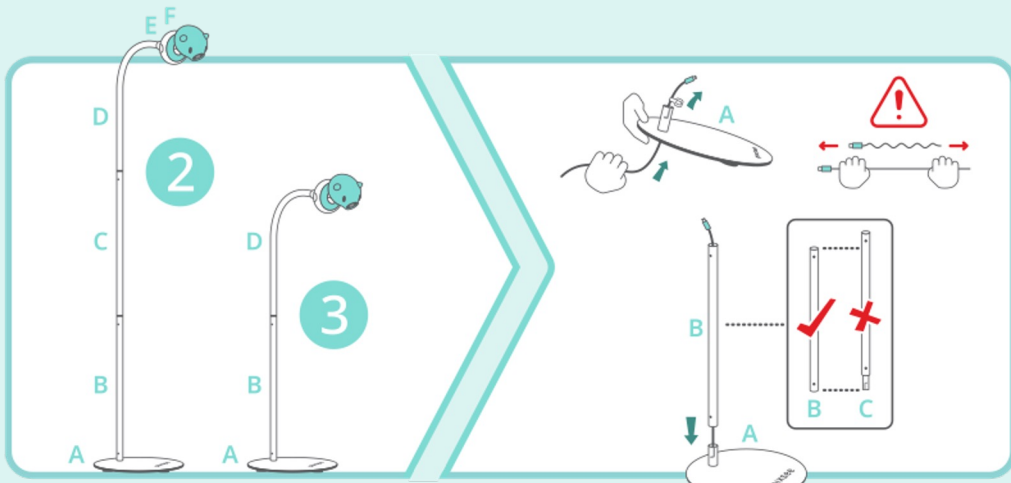
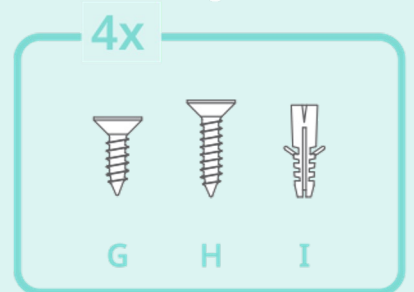
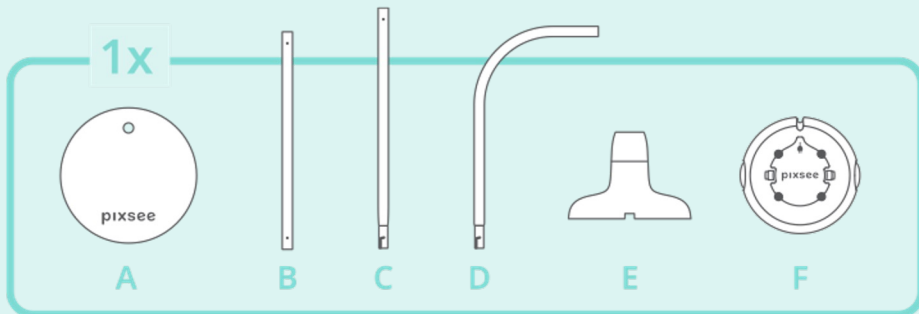

# 立地式安装步骤

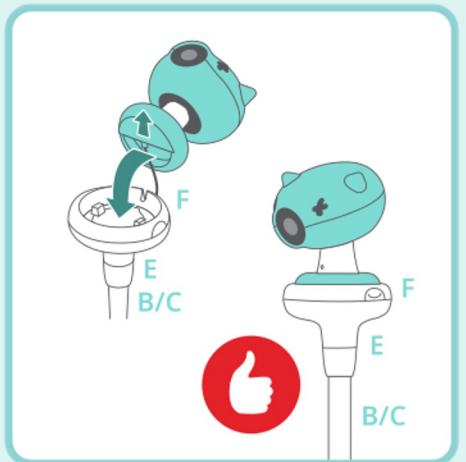
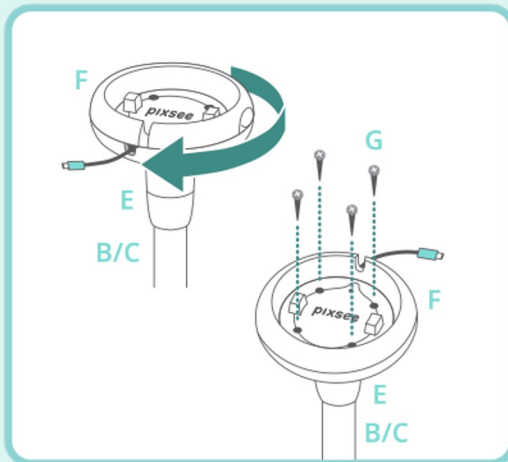
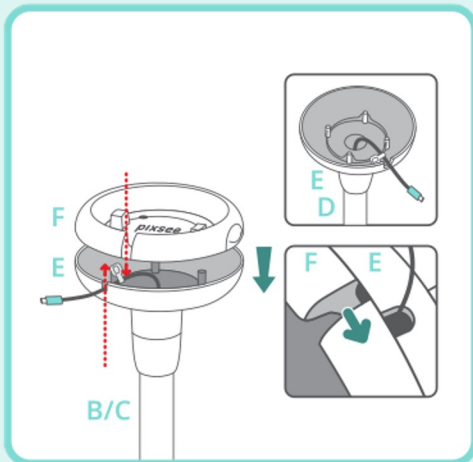
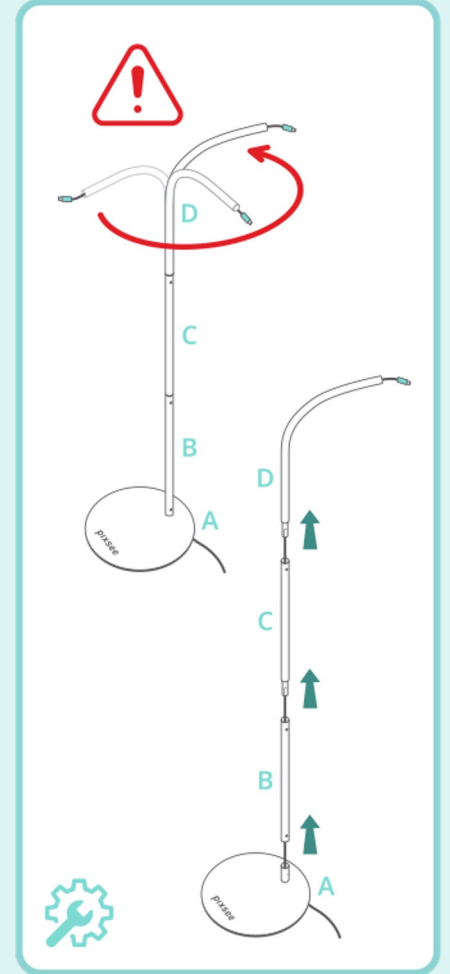
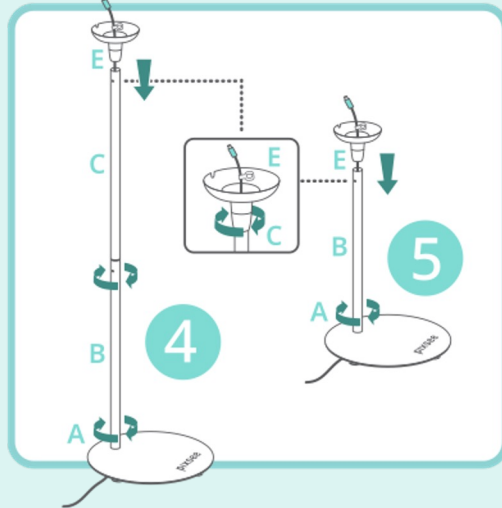
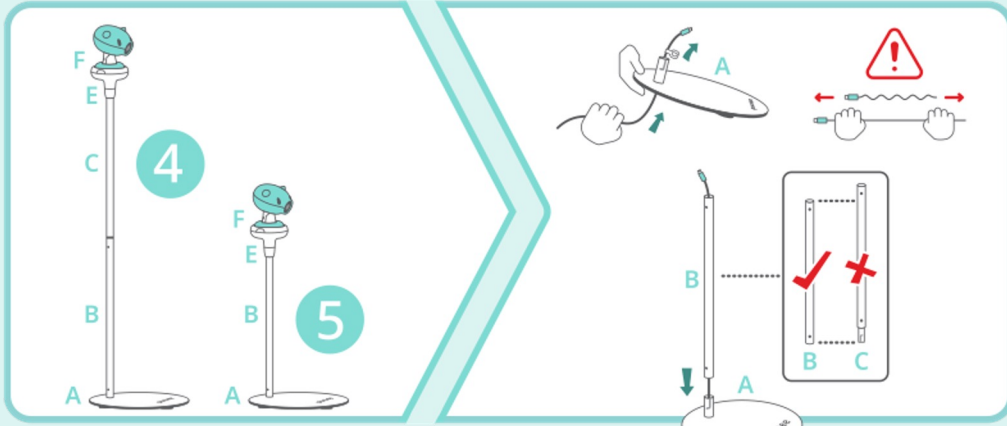

# 壁挂式安装步骤

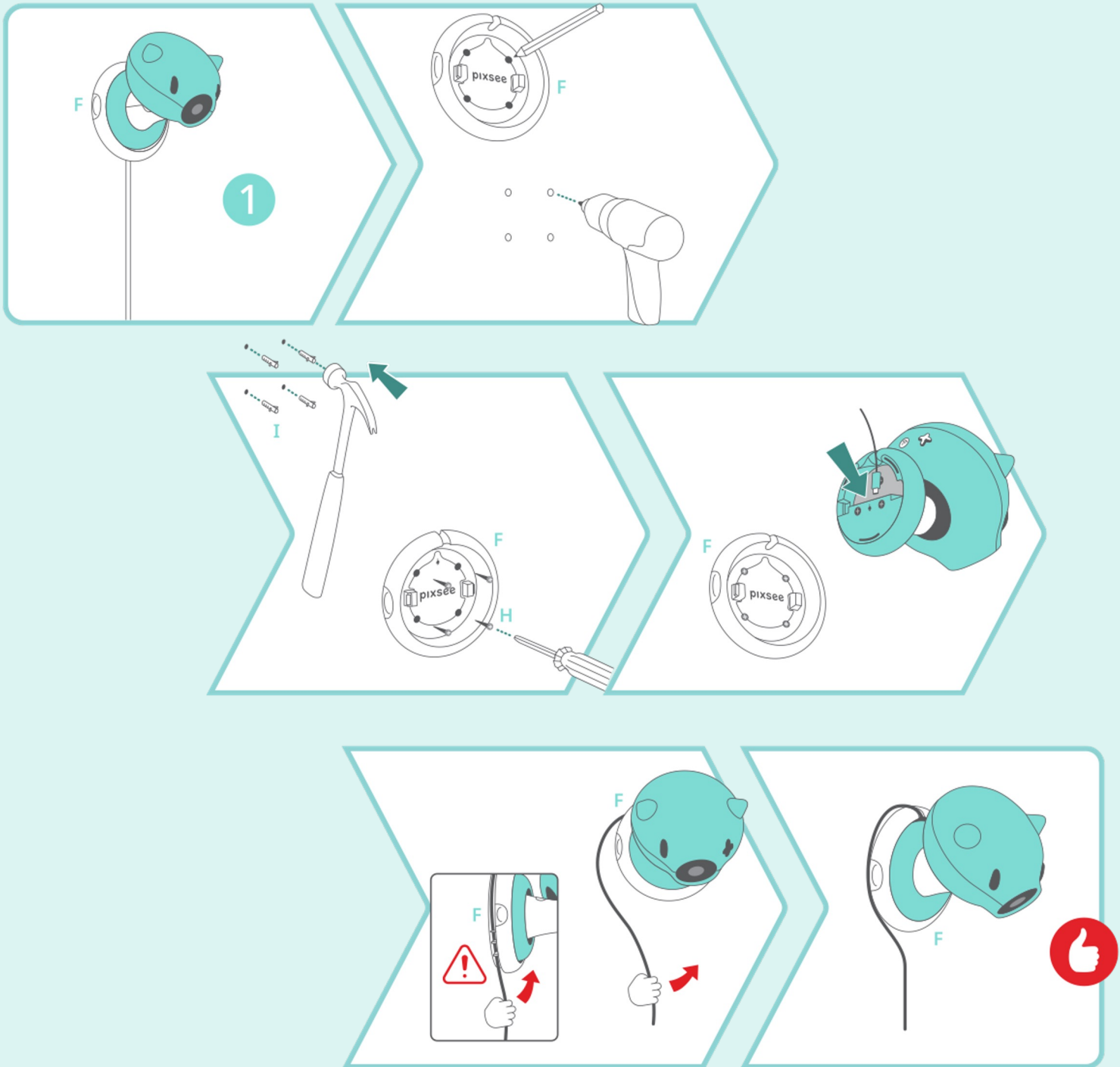

注意及其他声明事项说明

## 注意事项

- 儿童、老年人及残障人士应在监护和指导下使用本产品，勿让儿童擅自将本产品当作玩具。
- 请勿在倾斜或不稳定的台面上使用本产品，并远离热源，以免损坏塑胶部件，亦不可靠近或置于任何电器上。
- 本产品需插上电源线才可使用，若拔掉电源线，则无法开机。
- 本产品须单独使用额定电源110V~240V、额定电流5V/3A的插座，切勿以万用插座与其他电器同时使用。如果使用错误功率的电源变压器，有可能造成内部零件的损坏。
- 请勿使用未经国家安全认证的延长线转接，以免存在起火风险，同时也可能影响Wi-Fi传输及本产品效能。
- 请勿使用损坏的配件以及其他周边配件。
- 请勿以尖锐或金属物体接触插头触点。
- 请在实际使用产品前测试本产品及其所有功能，以便实际使用期间更熟悉顺利。
- 请勿用毛巾或毯子覆盖住本产品及电源线。
- 当产品正在运作时，会将系统正常的发热散逸到表面，故请勿将本产品长时间放置于膝上或是身体任一部位，以避免因高温而造成可能的身体不适。
- 请避免将本产品放置在磁性物质附近（例如喇叭及电视等）。
- 请勿在泄漏可燃气体、雨中或潮湿环境下使用或暴露本产品。
- 请勿在雷电天气下使用数据机连线上网，以避免遭受闪电的远距离电击。
- 请勿将本产品存放于靠近火源处或是丢入燃烧的火堆中，以免造成爆炸意外。
- 为维护飞航安全，请勿在航空工具上使用本产品。本产品的网络信号可能会对导航系统造成干扰。
- 如果本产品或电源线损坏，为避免危险，请勿自行尝试拆卸，请联系本公司售后服务处理。

## 友情提示

为降低婴儿猝死症候群的发生风险，我们温馨提示您「宝宝安全睡眠 环境5守则」，让主要照顾者对宝宝的睡眠环境进行检视，希望每个宝宝都拥有安全、温暖及香甜的睡眠。

- 宝宝与他人同床而睡，是婴儿猝死症的危险因素之一，就算是与父母或多胞胎兄弟姊妹，都建议要「同室不同床」。
- 使用毛巾被或毛毯保暖时，应裹至宝宝胸部，并将手臂露出，以减少盖住脸部的风险，或穿着一件式或睡袋型婴儿睡衣。
- 婴儿床表面必须坚实平整，不可有松软物件，如枕头、填充玩具等；且勿让宝宝睡在沙发、椅子、垫子或趴在父母或照顾者身上。
- 避免环境过热，勿穿着太多衣物与过度包裹婴儿。无空调设备时，宜注意通风。
- 建立无烟环境，勿让任何人在婴儿附近吸烟。

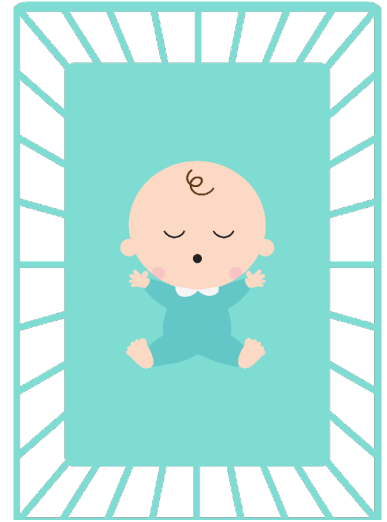

## 产品中有害物质名称及含量

部件名称	有害物质					
	铅 (Pb)	汞 (Hg)	镉 (Cd)	六价铬 (Cr(VI))	多溴联苯 (PBB)	多溴二苯醚 (PBDE)
机箱	○	○	○	○	○	○
主板	×	○	○	○	○	○
摄像头	×	○	○	○	○	○
扬声器	○	○	○	○	○	○
电源适配器	×	○	○	○	○	○

本表格依据 SJ/T 11364 的规定编制。  
○：表示有害物质在该部件所有均质材料中的含量均在 GB/T 26572 规定的限量要求以下。  
×：表示有害物质至少在该部件的某一均质材料中的含量超过 GB/T 26572 规定的限量要求。



## 警示语

CMIIT ID请参考产品铭牌。

## 设备废弃及回收处理

- 请遵守您所在地区法规适当地处理本产品和回收事项，并请您联络当地政府机关以便了解您所在地区相关的法规、回收事项及回收集点等相关资讯。
- 请您依照所在地区法规规定，将本产品带到收集点回收电气和电子设备。请勿将本产品与普通家庭垃圾一起处置。通过回收废弃设备，您可以为环境保护做出重要贡献。

## 清洁保养 (本体设备)

- 请使用洁净的干布进行清洁擦拭。
- 请勿在本产品旁使用强力溶剂如稀释剂、含苯溶剂或其他化学溶剂。
- 本产品仅具备生活性防泼功能，请勿使产品泼水、淋水或接触海水、盐水、加氯的水或饮料等液体。不当使用将导致本产品保修失效。
- 在清洁本产品之前，请务必先关闭电源并断开电源适配器的连接。

## 清洁保养 (支架)

- 请使用洁净的干布或用抹布沾温和清洁剂进行清洁擦拭。

## 免责声明

本说明书是以「现况」及「以目前明示的条件下」的状态提供给您。在法律允许的范围内，我司就本说明书不提供任何明示或默示的担保及保证，您应自行承担使用本说明书的全部风险。

您知悉我司有权随时修改本说明书。本产品规格或驱动程式一经改变，本说明书将会随之更新。本说明书更新的详细说明请您访问本产品官方网站，取得完整使用手册及最新资讯。

软件部分免责声明请参阅app内使用条款与隐私政策说明页面。

## 保修维护

当发生下列两种情况时，本产品将不再受到我司的保修及服务：

(1) 本产品曾经过非我司授权之维修、规格更改、零件替换，或其他未经过我司授权的行为。

(2) 无法提供产品序号或购买证明。

当您开始使用本产品时，即视为您已阅读、理解、接受和同意本产品使用说明书、重要警示语与安全提示说明、注意事项和免责声明等全部条款和内容。您承诺仅出于正当目的使用本产品，并且同意遵守本条款及任何我司制定的任何相关政策或者准则。关于保修维护的详细说明请您访问本产品官方网站，取得完整使用手册及最新资讯。

感謝您購買本產品  
讓pixsee與您一起展開陪伴寶寶的驚喜旅程！

任何問題？  
[hello@pixseecare.com](mailto:hello@pixseecare.com)

請您保留原始的購買收據並註明購買日期，作為保固期內需要維修服務時的依據。  
使用產品前請仔細閱讀本說明書，其中描述之功能如有更改，恕不另行通知。

請隨時參閱官方網站以獲得最新產品資訊。  
[www.pixseecare.com](http://www.pixseecare.com)



# 說明書內容

重要警語與安全提示 50

安裝準則 51

## pixsee智慧寶寶攝影機產品使用說明

攝影機外觀功能簡介 53

攝影機規格與燈號說明 54

攝影機安裝及連線步驟說明 55

攝影機配對及app使用設定 56

## pixsee五合一成長支架組安裝說明

內容物與使用模式 63

立地式安裝步驟 64

壁掛式安裝步驟 65

## pixsee注意及其他聲明事項說明

注意事項與NCC警語 67

友善建議、設備廢棄及回收處置 68

清潔保養與免責聲明 69

保固維護 69



## 重要警語與安全提示



### 警告：絞勒窒息危險。

- 請留意孩童易受繩索纏繞而發生絞勒窒息之意外。
- 請勿讓孩童接觸電線 (請保持3.5英呎 (1公尺)以上的距離)。
- 請勿將智慧寶寶攝影機放在嬰兒床或嬰兒護欄內。
- 請使用本產品隨箱提供的變壓器，並切勿將上述變壓器插入未經國家安全認證之延長線。
- 本智慧寶寶攝影機為輔助工具，無法取代具成人監督意義之功能及責任。
- 請勿將嬰兒獨自留在家中，嬰兒必須隨時有成人之照護並回應其需求。



### 警告：請勿讓寶寶觸碰搖晃支架。

- 應留意立架使用場域安全，不可讓幼童觸碰嬉戲，並於不使用時，也應收納妥當，存放於孩童無法接觸的安全地點，才能有效避免孩童被夾傷、壓傷或卡住等意外事故發生。  
(專利五合一成長支架需另選購)

## 安裝準則

- 請將pixsee智慧寶寶攝影機和手機裝置一起使用，您必須在上述兩個裝置之間建立無線電連接，該連接範圍將受到連網環境條件的影響。
- 任何大型金屬物體，例如冰箱、鏡子、鋸刀櫥櫃、金屬門或鋼筋混凝土皆可能阻擋本產品之無線電信號。
- 其他固體如牆壁等結構，或通過無線電及電氣設備(例如電視、計算機、無線電話、螢光燈或調光開關等)，也可能降低本產品之信號強度。
- 使用其他2.4GHz類產品，例如無線網絡（Wi-Fi®路由器）、Bluetooth™系統或微波爐，也可能干擾本產品之信號強度，因此請保持本產品距離上述類型產品至少1.5公尺的距離，或當上述類型產品疑似引起干擾，請將其關閉。
- 如果信號微弱，請嘗試移動本產品至房間不同位置。

pixsee 智慧寶寶攝影機  
產品使用說明

智慧寶寶攝影機

智慧寶寶攝影機

智慧寶寶攝影機

智慧寶寶攝影機

智慧寶寶攝影機

智慧寶寶攝影機

智慧寶寶攝影機

智慧寶寶攝影機

智慧寶寶攝影機

智慧寶寶攝影機

智慧寶寶攝影機

智慧寶寶攝影機

智慧寶寶攝影機

## 攝影機外觀功能簡介

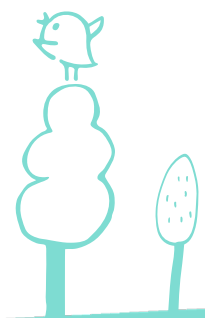
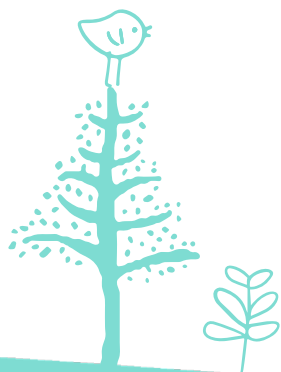
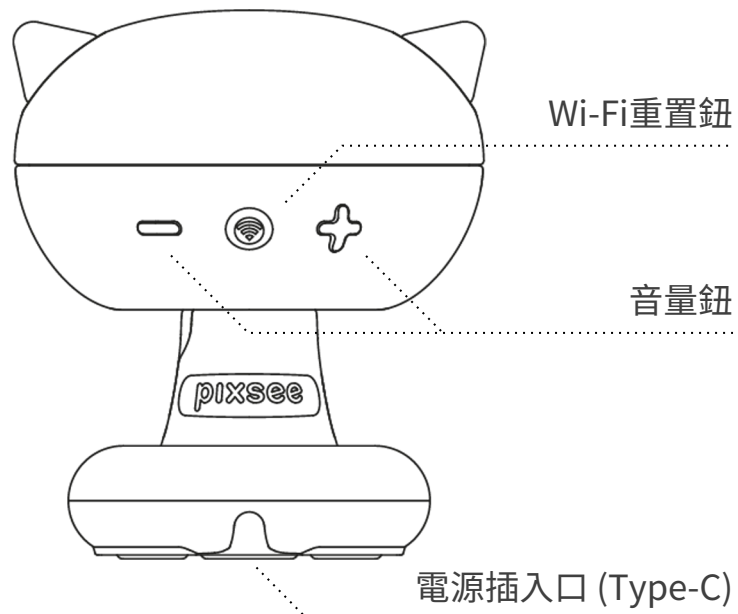
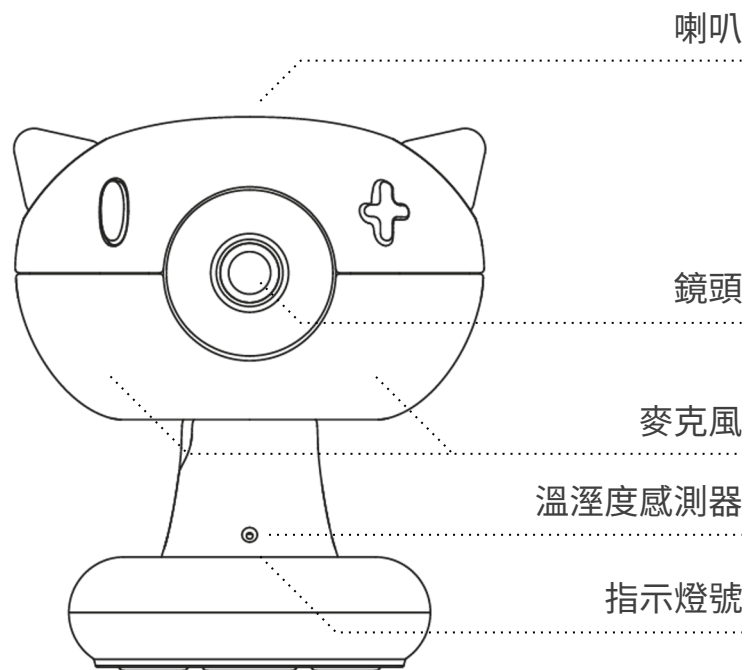

## 攝影機規格

外觀尺寸	116 x 112x 131mm
重量	322g
攝影鏡頭	1080p FHD錄影畫質、500萬畫素6層全玻璃鏡頭、超廣角鏡頭模組、抗反射、防眩光鍍膜
夜視功能	高量子效率夜視CMOS感光元件、無紅光LED夜視濾鏡(3公尺距離範圍、波長940nm)、環境光源感測器
喇叭及麥克風	內建喇叭與高感度麥克風
溫濕度偵測器	可偵測環境範圍： 溫度為0°C ~ 60°C (32°F ~ 140°F) 濕度為10% ~90%
安全性	內建安全加密晶片、AES-128 銀行級加密技術
電源	直流5伏特2安培
電壓	100 - 240伏特
連網環境需求	Wi-Fi 802.11a/b/g/n/ac, 2.4GHz or 5GHz (WPA, WPA2 encryption supported); 為享有較佳使用體驗，建議Wi-Fi 上下傳速度至少各5Mbps 以上，體驗較佳。 <b>提醒:使用手機熱點連線，可能影響連線及瀏覽品質</b>
App行動裝置系統版本需求	iOS 13.0 或以上 Android 10.0 或以上
配件	Type-C 電源線 (3公尺) 專利五合一成長支架 (需另選購)

## 燈號說明

- 橘黃閃燈：裝置首次啓動或完成重置
- 紅色閃燈：系統升級中
- 藍色閃燈：新增Wi-Fi設定
- 綠色閃燈：Wi-Fi連線中
- 綠色恆燈：正常連線運作中
- 藍紫色恆燈：靜音模式
- 冷白色恆燈：遙控拍照模式
- 冷白色閃燈：倒數計時狀態
- 藍+綠色閃燈：網路連線或傳輸訊號狀況不佳

最新的燈號說明請參閱官方網站



## 攝影機安裝及連線步驟說明

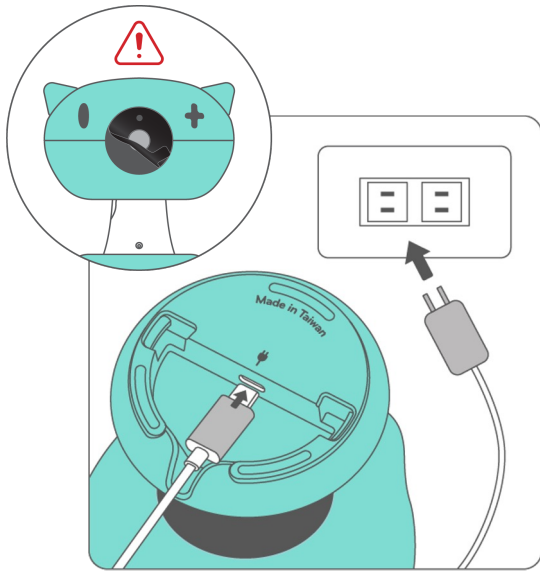

請先將鏡頭黑色保護膜撕除

### 1 連接電源

請使用隨盒提供的USB電源線連接至pixsee智慧寶寶攝影機

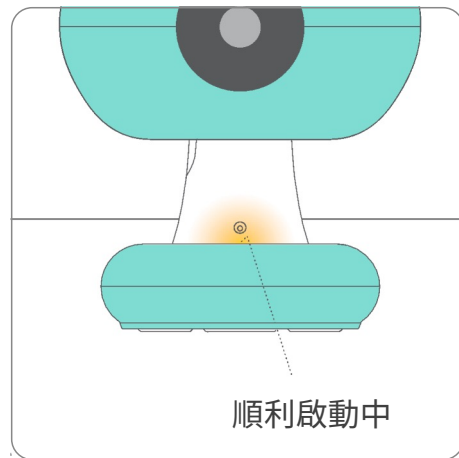

2 確認裝置啟動燈號  
便可準備進行行動裝置app設定連接步驟

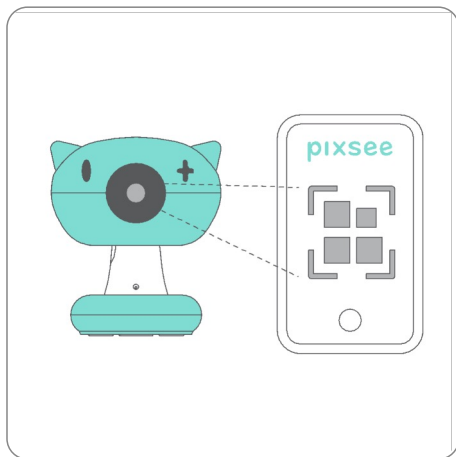

3 下載pixsee app，依循指示操作，  
與裝置完成配對。

請依循app指示步驟操作

4 調整鏡頭角度，完成!

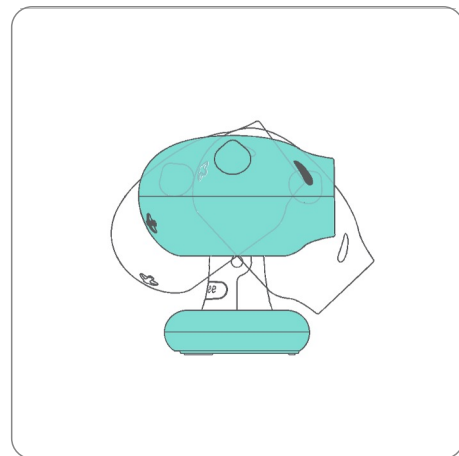

# 攝影機配對及app使用設定

為了確保pixsee連線品質與使用體驗，在您進行攝影機及app設定前，請先確認以下網路設定狀態：

1 家中Wi-Fi網路確實開啟並連線正常。

注意：家中Wi-Fi網路AP如果有超過一個以上，須請您先選擇並連接之網路AP。

2 手機開啟Wi-Fi，並且確認手機Wi-Fi的設定確實連線到您指定的網路AP。

## 1. 註冊/登入帳號



### 1-1 開始註冊

輸入電子郵件與密碼，點選 **繼續**，繼續電子信箱認證流程，完成認證流程，執行1-2。您也可利用WeChat/Apple ID完成註冊及登入。



### 1-2 登入帳號

進入app，輸入電子郵件與密碼，或是以WeChat/Apple ID登入，開始使用app。



# 攝影機配對及app使用設定

## 2. 建立及綁定會員資料

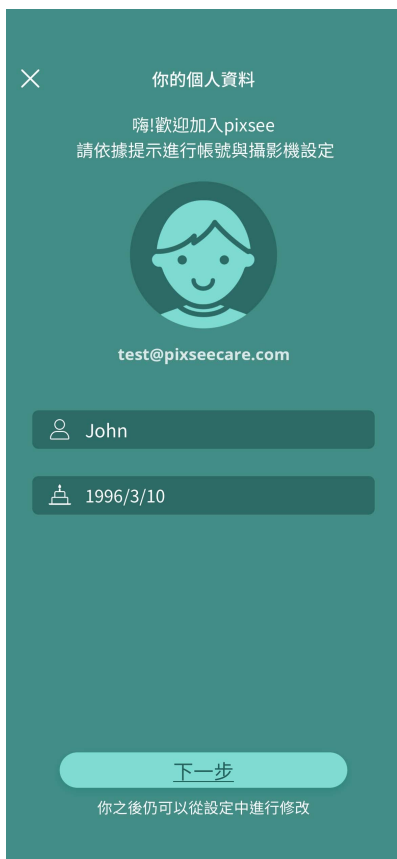

### 2-1 建立使用者帳號

輸入您的名字與生日資訊，  
點選 **下一步** 繼續。



### 2-2 建立寶寶資訊

輸入寶寶名字與相關訊息，  
點選 **下一步** 以繼續。

# 攝影機配對及app使用設定

## 3. 建立裝置



### 3-1 新增攝影機

請點選 **我已經擁有pixsee** 繼續下一步。



### 3-2 確認燈號

先確認攝影機上燈號顯示橘燈閃動，點選 **新增攝影機**



如果機器未顯示燈號  
請按下  
**我未看到燈號閃動**  
進行攝影機重置  
(Reset)

## 4 網路連線與裝置配對

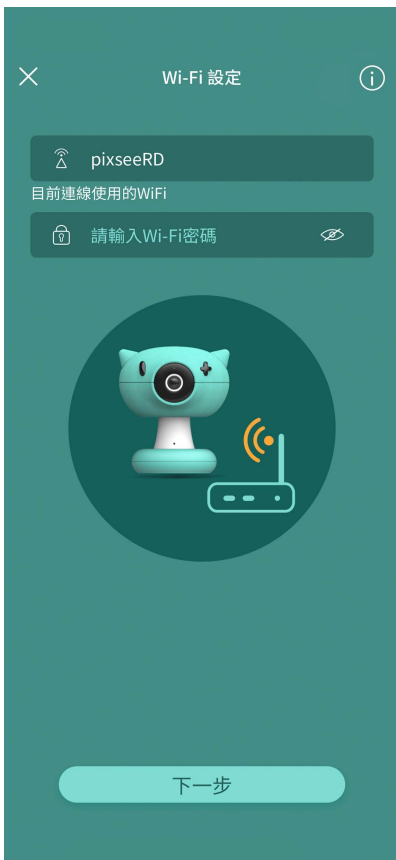

### 4-1 Wi-Fi 設定

pixsee會出現預設連線使用之Wi-Fi網路，請確認欲使用的Wi-Fi網路，並輸入Wi-Fi密碼，點選 **下一步** 繼續設定。



### 4-2 QR code 掃描

請將手機螢幕上的QR code，放置於pixsee鏡頭前約20-25cm進行掃描，並取得網路連線資訊，當聽到語音提示 QR code scan successful 請點選按鈕，繼續進行設定。



如果沒聽到掃描成功提示音，請將螢幕亮度調整至最亮，或移動手機QR code畫面和鏡頭的距離進行重新掃描，直到掃描成功

# 攝影機配對及app使用設定

## 4 網路連線與裝置配對

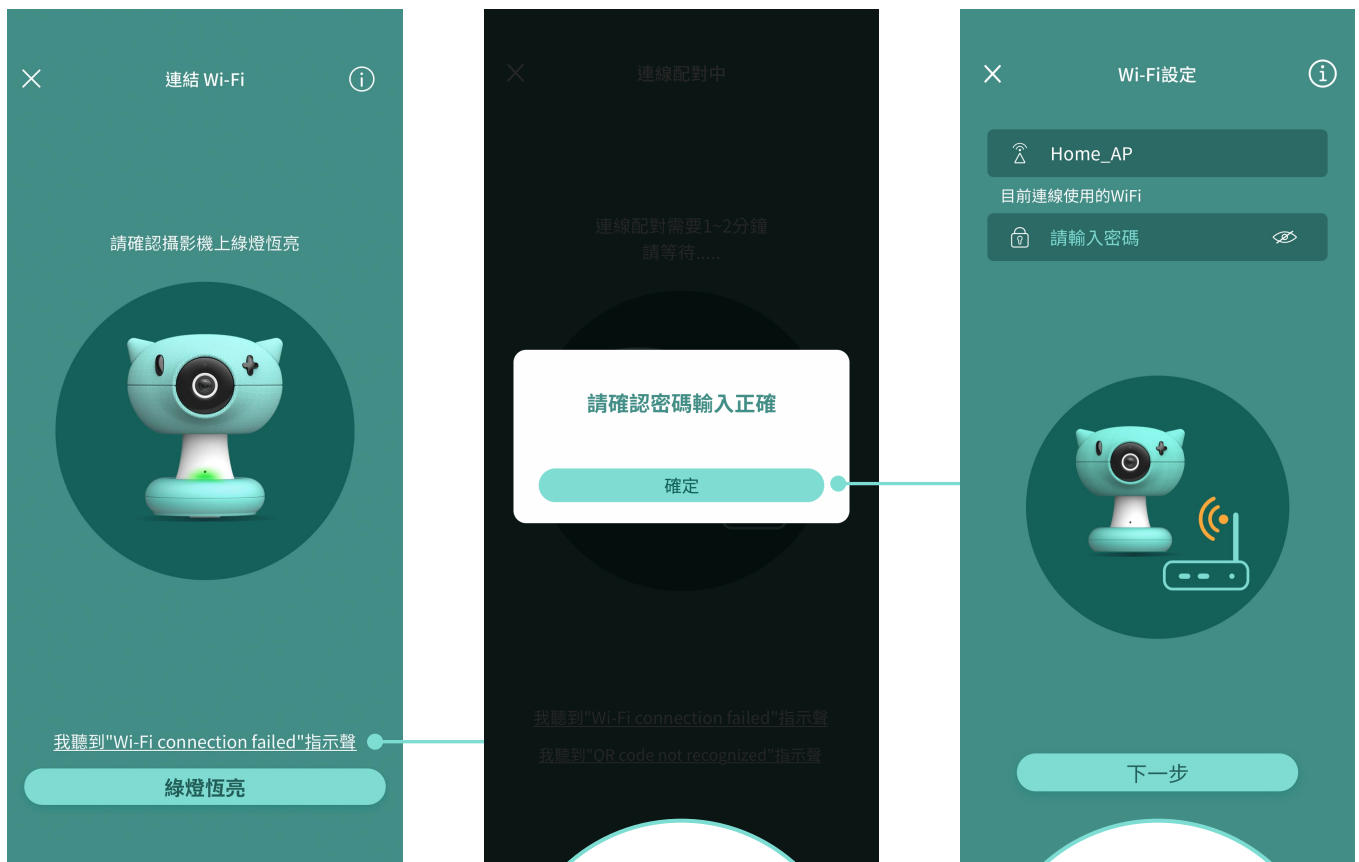

### 4-3 連接Wi-Fi

當看到並確認攝影機上燈號顯示綠燈恆亮，按下指示按鈕繼續進行設定。

Wi-Fi  
連接失敗畫面  
請點選確認後，重新  
輸入正確之Wi-Fi  
密碼

重新設置連線  
請遵照指示重新設定  
pixsee

# 攝影機配對及app使用設定

## 4 網路連線與裝置配對



### 4-4 連線配對

進行連線配對約需1~2分鐘，請耐心等待配對過程。



### 4-5 完成配對設定

當畫面出現連線畫面表示設定成功，可開始體驗pixsee美妙愉快的育兒旅程嚕~

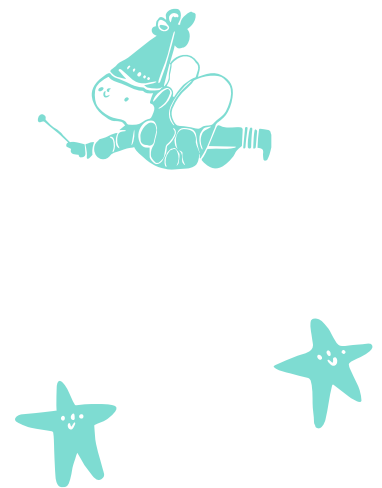

# pixsee 五合一成長支架組 安裝說明

如已持有pixsee智慧寶寶攝影機，請先完成攝影機設置，  
確認最佳攝影位置後再進行支架安裝。

# 內容物與使用模式

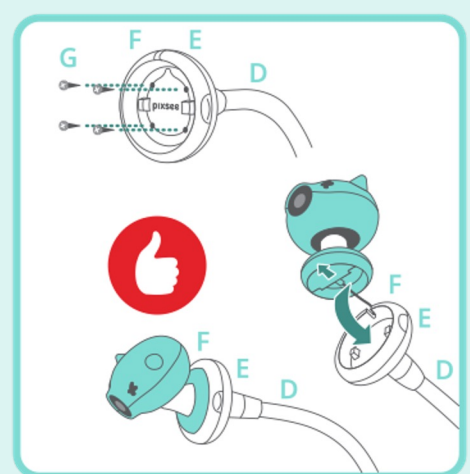
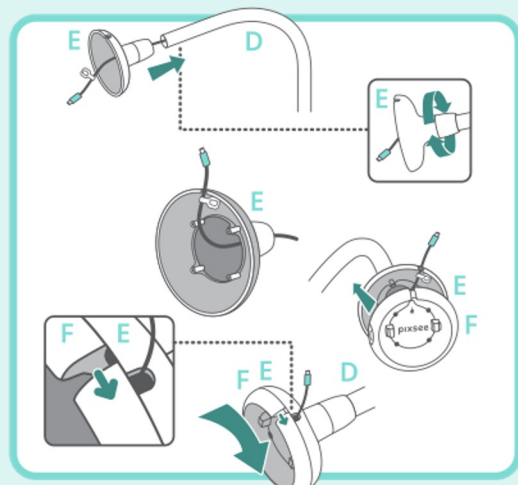
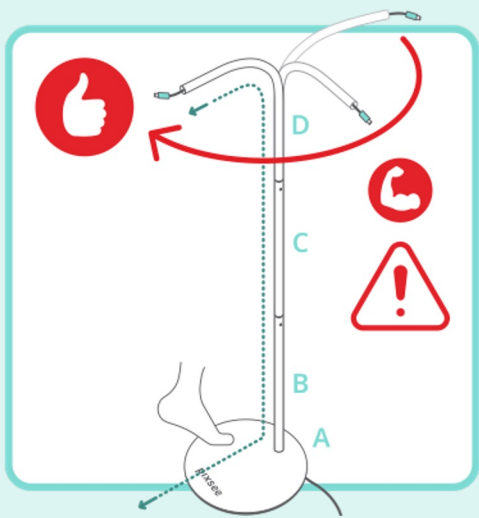
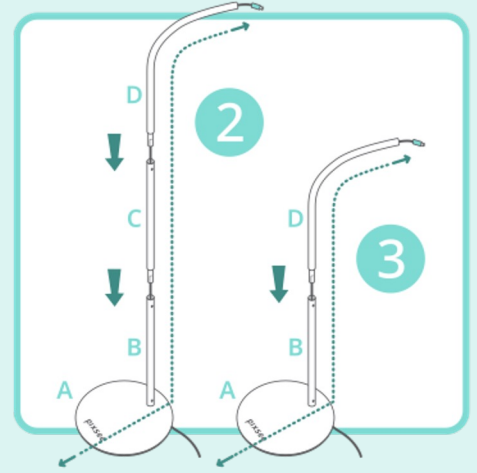
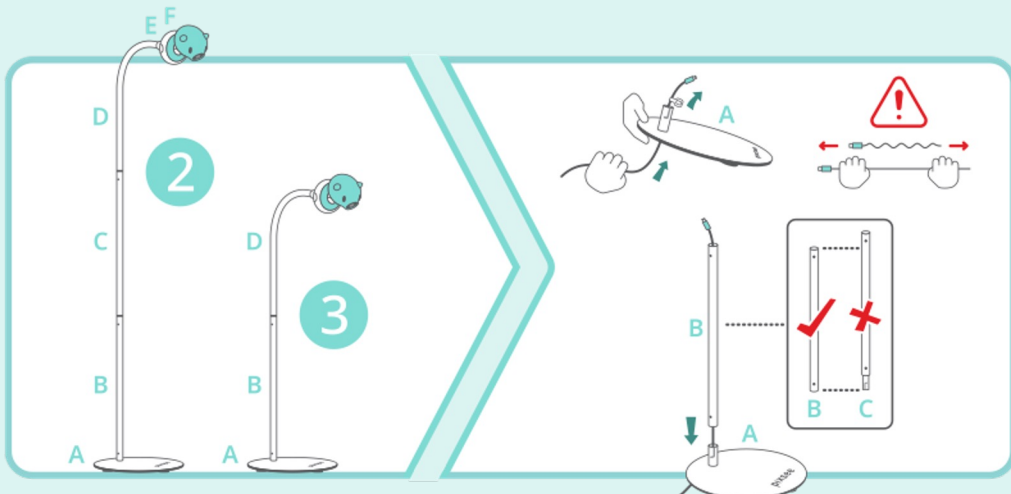
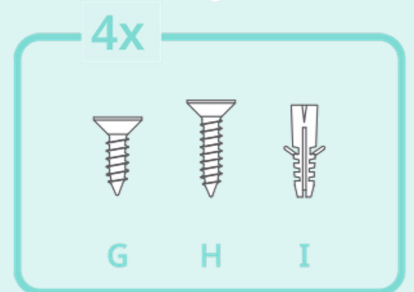
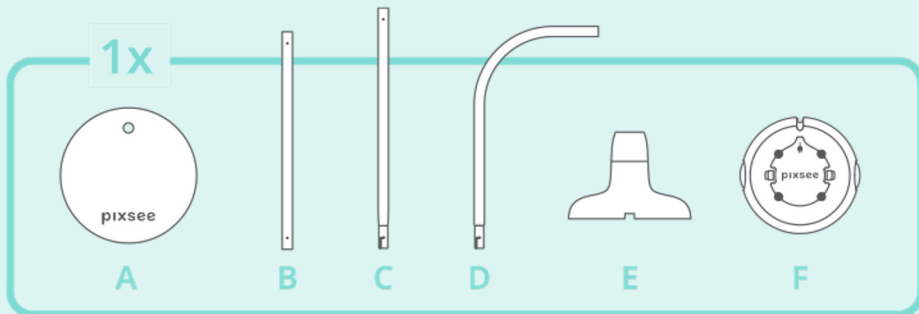

# 立地式安裝步驟

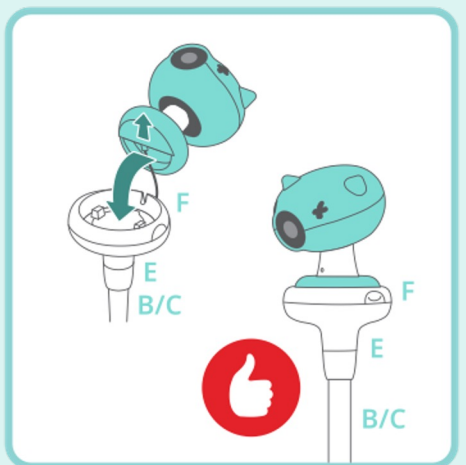
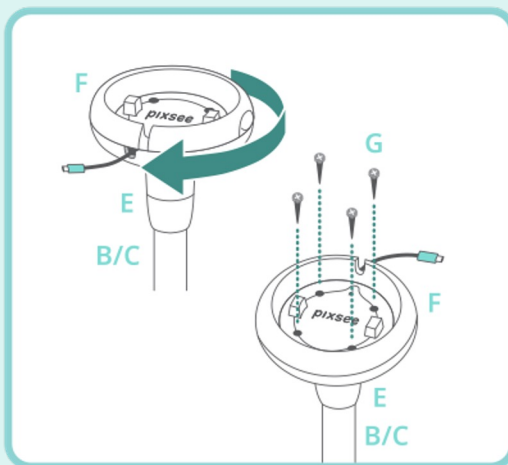
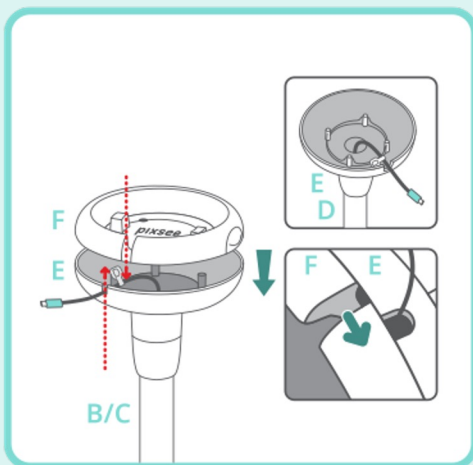
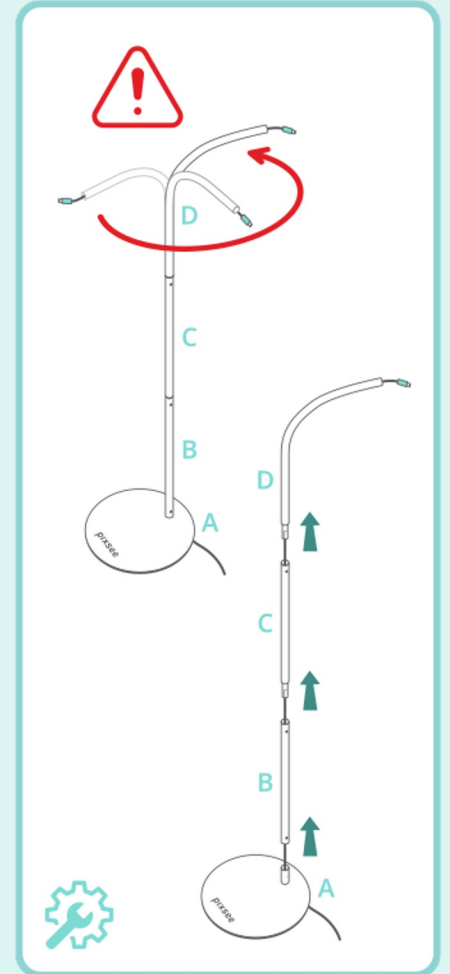
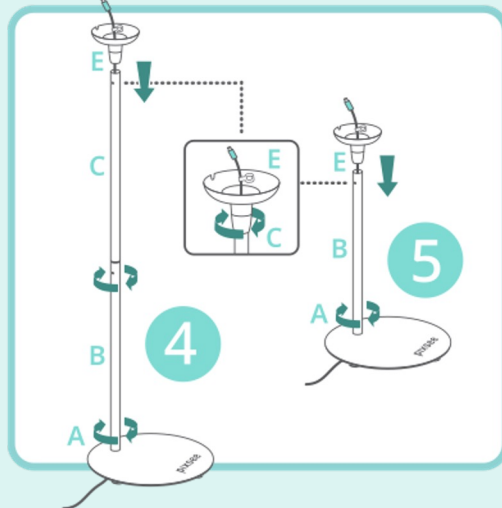
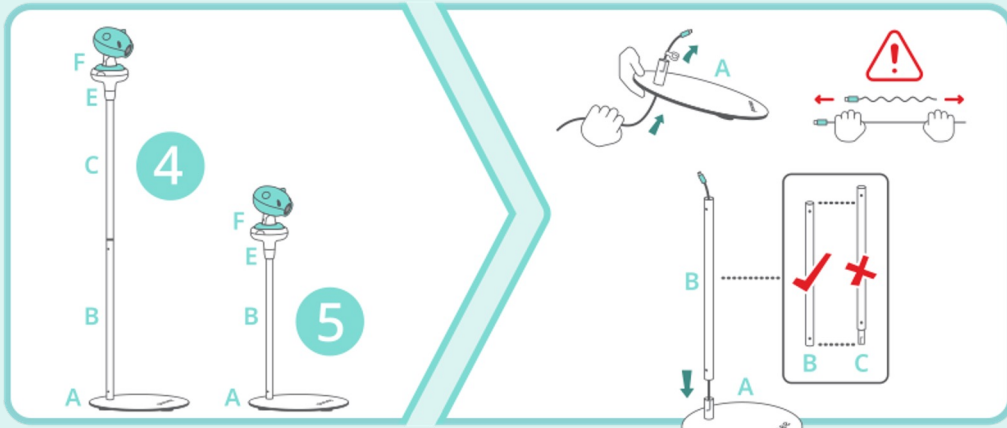



# 壁掛式安裝步驟

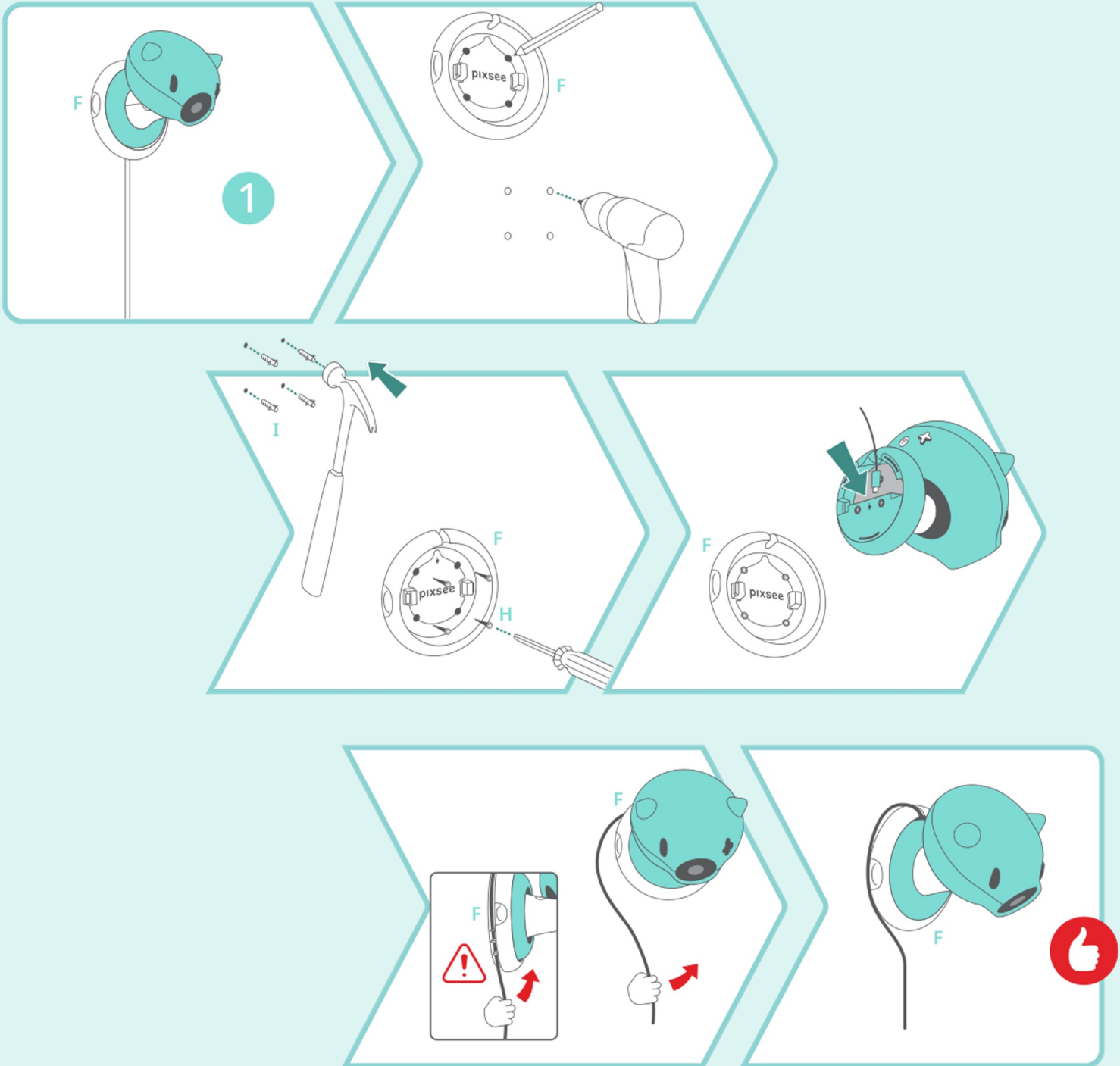

pixsee 注意及其他聲明事項說明

## 注意事項

- 兒童、老年人及身障人士應在監護下和指導下使用本產品，勿讓兒童擅自將本產品當作玩具。
- 請勿在傾斜或不穩定的檯面上使用本產品，並遠離熱源，以免損壞塑膠部件，亦不可靠近或置於任何電器上。
- 本產品需插上電源線才可使用，若拔掉電源線，則無法開機。
- 本產品須單獨使用額定電源110V~240V，額定電流5V/3A的插座，切勿以萬用插座與其他電器同時使用。如果使用錯誤功率的電源變壓器，有可能造成內部零件的損壞。
- 請勿使用未經國家安全認證之延長線轉接，以免存在起火風險，同時也可能影響Wi-Fi傳輸及本產品效能。
- 請勿使用損壞的配件以及其他周邊配備。
- 請勿以尖銳或金屬物體接觸插頭觸點。
- 請在實際使用產品前測試本產品及其所有功能，以幫助實際使用期間更熟悉順利。
- 請勿將毛巾或毯子覆蓋住本產品及電源線。
- 當產品正在運作時，會將系統正常之發熱散逸到表面，請勿將本產品長時間放置在膝上或是身體任一部位，以避免因高溫而可能造成的身體不適。
- 請避免將本產品放置在磁性物質附近（例如喇叭及電視等）。
- 請勿在洩漏可燃氣體、雨中或潮濕環境下使用或暴露本產品。
- 請勿在雷電天氣下使用數據機連線上網，以避免遭受閃電的遠距電擊。
- 請勿將本產品存放於靠近火源處或是丟入燃燒的火堆中，以免造成爆炸意外。
- 為維護飛航安全請勿在航空工具上使用，本產品網路訊號可能對導航系統造成干擾。
- 如果本產品或電源線損壞，為避免危險，請勿自行嘗試拆卸，請聯繫本公司售後服務處理。

## NCC警語

- 依據「低功率電波輻射性電機管理辦法」第十二條：經型式認證合格之低功率射頻電機，非經許可，公司、商號或使用者均不得擅自變更頻率、加大功率或變更原設計之特性及功能。
- 「低功率電波輻射性電機管理辦法」第十四條：低功率射頻電機之使用不得影響飛航安全及干擾合法通信；經發現有干擾現象時，應立即停用，並改善至無干擾時方得繼續使用。前項合法通信，指依電信法規定作業之無線電通信。低功率射頻電機須忍受合法通信或工業、科學及醫療用電波輻射性電機設備之干擾。

## 友善建議

為降低嬰兒猝死症候群之發生風險，國民健康署整理了「寶寶安全睡眠環境5守則」，讓主要照顧者對寶寶的睡眠環境進行檢視，希望每個寶寶都擁有安全、溫暖及香甜的睡眠。

- 寶寶與他人同床而睡，是嬰兒猝死症的危險因素之一，就算是與父母或多胞胎兄弟姊妹，都建議要「同室不同床」。
- 使用毛巾被或毛毯保暖時，應裹至寶寶胸部，並將手臂露出，以減少蓋住臉部的機會，或穿著一件式或睡袋型嬰兒睡衣。
- 嬰兒床表面必須堅實平整，不可有鬆軟物件，如枕頭、填充玩具等；且勿讓嬰兒睡在沙發、椅子、墊子或趴睡在父母或照顧者身上。
- 避免環境過熱，勿穿著太多衣物與過度包裹嬰兒。無空調設備時，宜注意通風。
- 建立無菸環境，勿讓任何人在嬰兒附近吸菸。

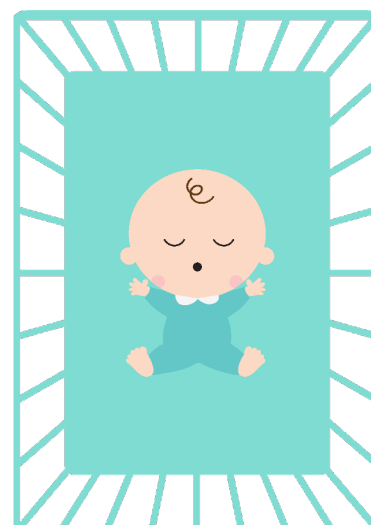

資料來源：台灣衛福部國民健康署

## 產品中有害物質名稱及含量

單元	設備名稱: pixsee 智慧寶寶攝影機 型號: SC-PIXM01					
	限用物質及其化學符號					
	鉛 (Pb)	汞 (Hg)	鎘 (Cd)	六價鉻 (Cr(VI))	多溴聯苯 (PBB)	多溴二苯醚 (PBDE)
電路板	—	○	○	○	○	○
外殼	○	○	○	○	○	○
攝影機	—	○	○	○	○	○
喇叭	○	○	○	○	○	○
變壓器	—	○	○	○	○	○

備考1. "超出 0.1 wt%" 係指限用物質之百分比含量超出百分比含量基準值。  
備考2. "○" 係指該項限用物質之百分比含量未超出百分比含量基準值。  
備考3. "—" 係指該項限用物質為排除項目。

## 設備廢棄及回收處置

- 請遵守您所在地區法規適當地處理本產品和回收事項，並請您聯絡當地政府機關以便瞭解您所在地區相關的法規、回收事項及回收集點等相關資訊。
- 請您依照所在地區法規規定，將本產品帶到收集點回收電氣和電子設備。請勿將本產品與普通家庭垃圾一起處置。透過回收廢棄設備，您可以為環境保護做出重要貢獻。

## 清潔保養 (本體設備)

- 請使用潔淨的乾布進行清潔擦拭。
- 請勿在本產品旁使用強力溶劑如稀釋劑、含苯溶劑或其他化學溶劑。
- 本產品僅具備生活性防潑功能，請勿使產品潑水、淋水或接觸海水、鹽水、加氯的水或飲料等液體。不當使用將導致本產品保固失效。
- 在清潔本產品之前，請務必先關閉電源並斷開電源适配器的連接。

## 清潔保養 (支架)

- 請使用潔淨的乾布或用抹布沾溫和清潔劑進行清潔擦拭。

## 免責聲明

本說明書是以「現況」及「以目前明示的條件下」的狀態提供給您。在法律允許的範圍內，本公司就本說明書不提供任何明示或默示的擔保及保證，您應自行承擔使用本說明書的全部風險。

您知悉本公司有權隨時修改本說明書。本產品規格或驅動程式一經改變，本說明書將會隨之更新。本說明書更新的詳細說明請您造訪本產品官網，取得完整使用手冊及最新資訊。

軟體部分免責聲明請參閱app內使用條款與隱私政策說明頁面。

## 保固維護

當下列兩種情況發生時，本產品將不再受到本公司之保固及服務：

- (1) 本產品曾經過非神寶醫資授權之維修、規格更改、零件替換，或其他未經過本公司授權的行為。
- (2) 無法提供產品序號或購買證明。

當您開始使用本產品時，即視為您已閱讀、理解、接受和同意本產品使用說明書、重要警語與安全提示說明、注意事項和免責聲明等全部條款和內容。您承諾僅出於正當目的使用本產品，並且同意遵守本條款及任何神寶醫資制定的任何相關政策或者準則。

關於保固維護的詳細說明請您造訪本產品官網，取得完整使用手冊及最新資訊。

**pixsee**  
create beautiful moments

[www.pixseecare.com](http://www.pixseecare.com)  
[www.pixseecare.com.cn](http://www.pixseecare.com.cn)  
[www.pixseecare.com/uk](http://www.pixseecare.com/uk)